

1: 9.7 ←	6: *10.3 ↗	Serie	99.4
2: *10.2 ↘	7: 9.2 →		
3: *10.3 ↗	8: 10.0 ↘	Total	99.4
4: 10.0 →	9: *10.4 ↗		
5: 9.9 ↗	10: 9.4 →		

11: *10.3 ↘	16: 9.8 ←	Serie	100.7
12: *10.4 ↓	17: 9.9 ←		
13: *10.2 ↗	18: *10.5 ↑	Total	200.1
14: 9.9 ↘	19: 9.6 ↘		
15: 9.7 →	20: *10.4 ←		

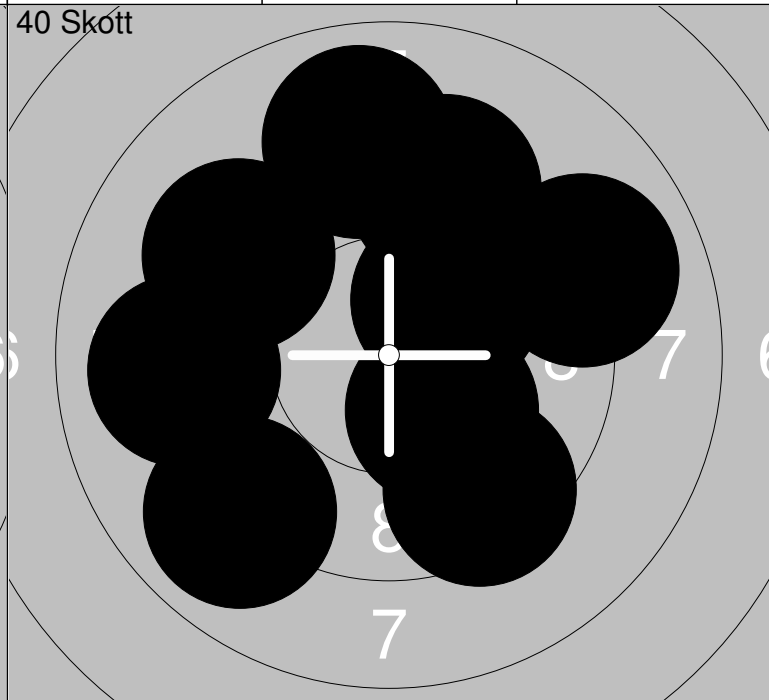
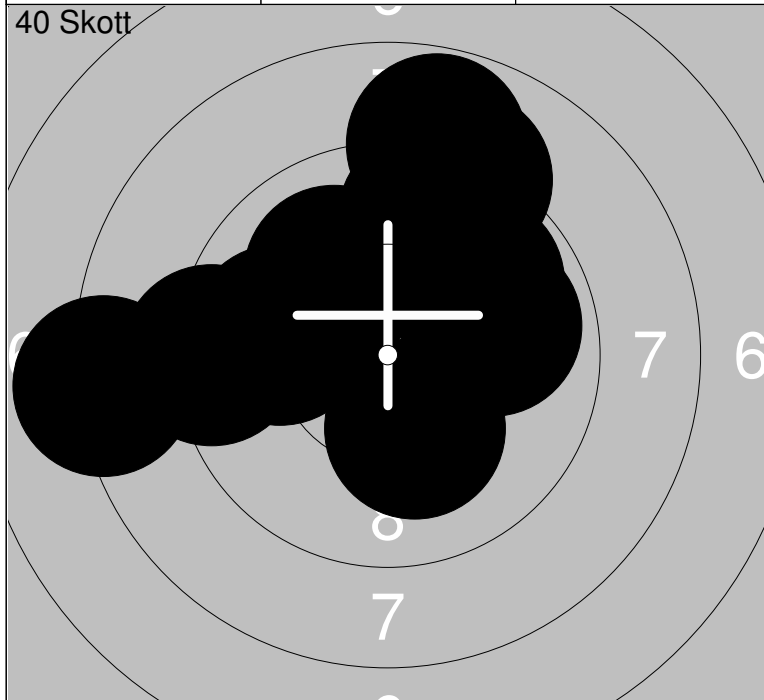

21: 9.2 ←	26: 9.9 ←	Serie	94.5
22: 9.1 ↗	27: 9.8 ↗		
23: 9.5 ↗	28: *10.2 ↓	Total	294.6
24: 8.8 ↗	29: 9.9 →		
25: 8.1 ←	30: 10.0 ↗		

31: 8.9 ↘	36: 9.0 →	Serie	84.2
32: 9.0 ←	37: *10.2 ↘		
33: 9.3 ↗	38: 8.9 ↑	Total	378.8
34: *10.2 ↗	39: 9.4 ↘		
35: 9.3 ↘	40: 0.0		

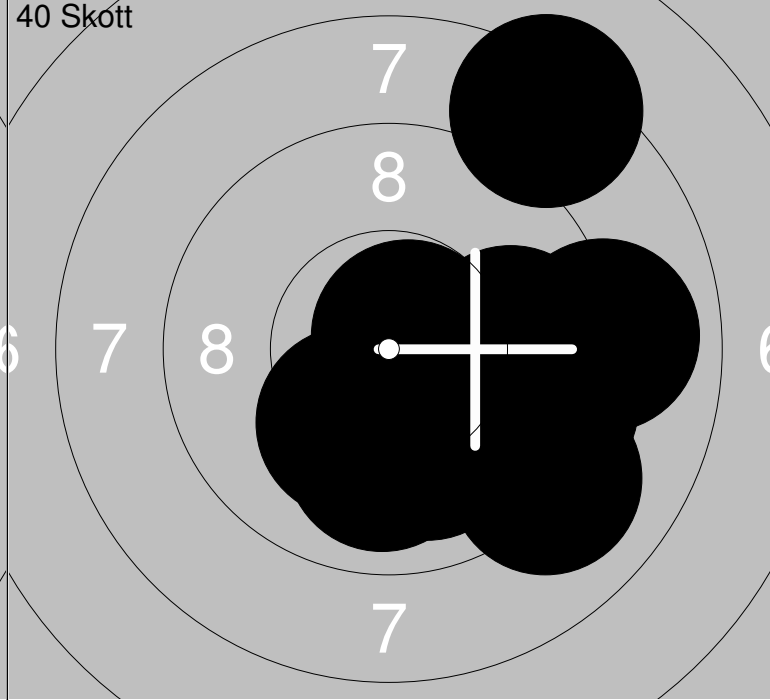
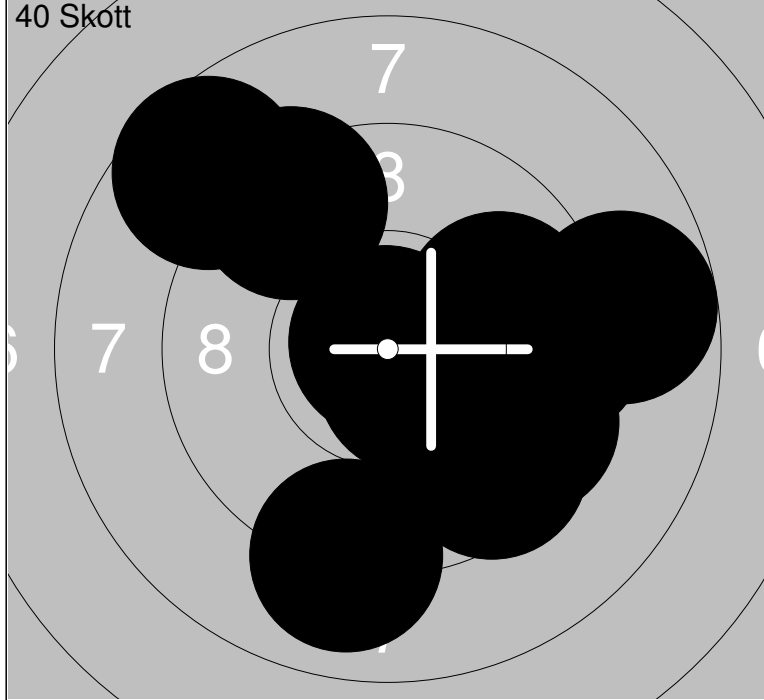

1: 9.4 →	6: 8.6 ↗	Serie	95.5
2: 9.3 ↗	7: 9.9 →		
3: *10.6 ↘	8: 8.8 →	Total	95.5
4: 9.5 ↘	9: *10.9 ↗		
5: 9.5 ↘	10: 9.0 ↓		

11: *10.7 ↗	16: 9.8 →	Serie	96.0
12: 8.3 ↗	17: 10.0 ↓		
13: 9.0 →	18: 9.1 ↓	Total	191.5
14: 9.4 →	19: *10.2 ↘		
15: 10.0 ↓	20: 9.5 →		

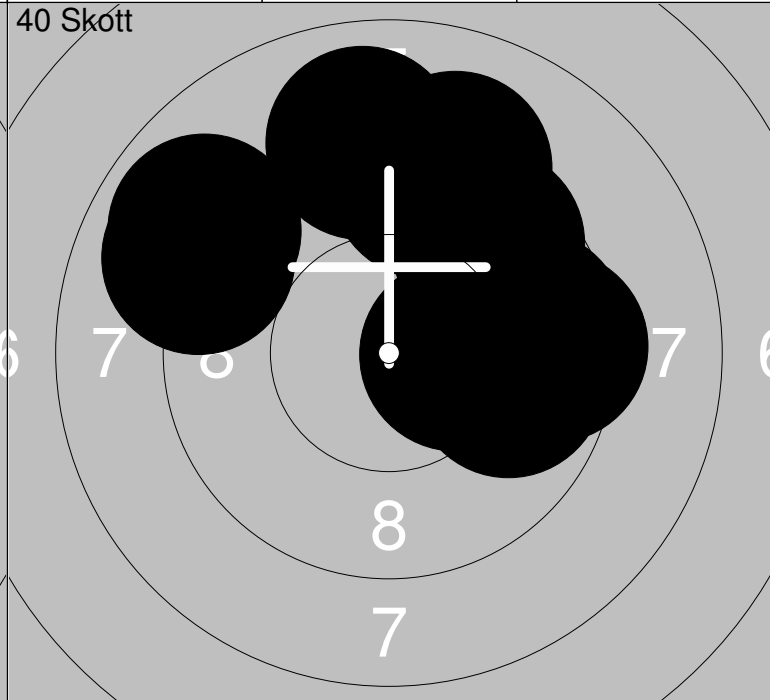
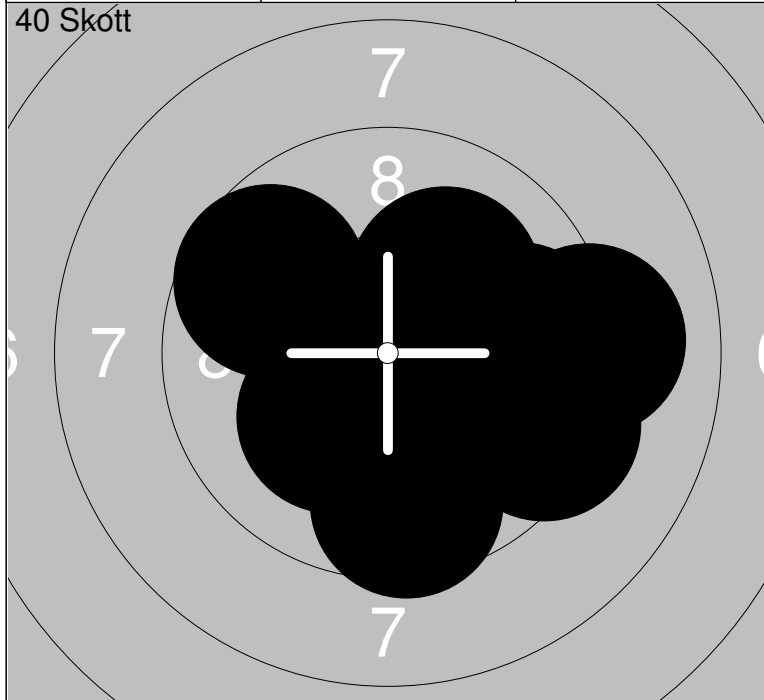

21: 9.3 →	26: *10.2 ↘	Serie	99.1
22: *10.5 ↘	27: *10.6 ↓		
23: 9.1 →	28: 9.7 →	Total	290.6
24: 9.6 ↓	29: 9.7 ↗		
25: 10.1 ↗	30: *10.3 ↓		

31: 9.4 →	36: 9.6 →	Serie	94.0
32: 9.3 ↗	37: 9.8 →		
33: *10.3 →	38: 9.1 ↗	Total	384.6
34: 9.0 ↗	39: 9.6 ↗		
35: 9.0 ↗	40: 8.9 ↗		

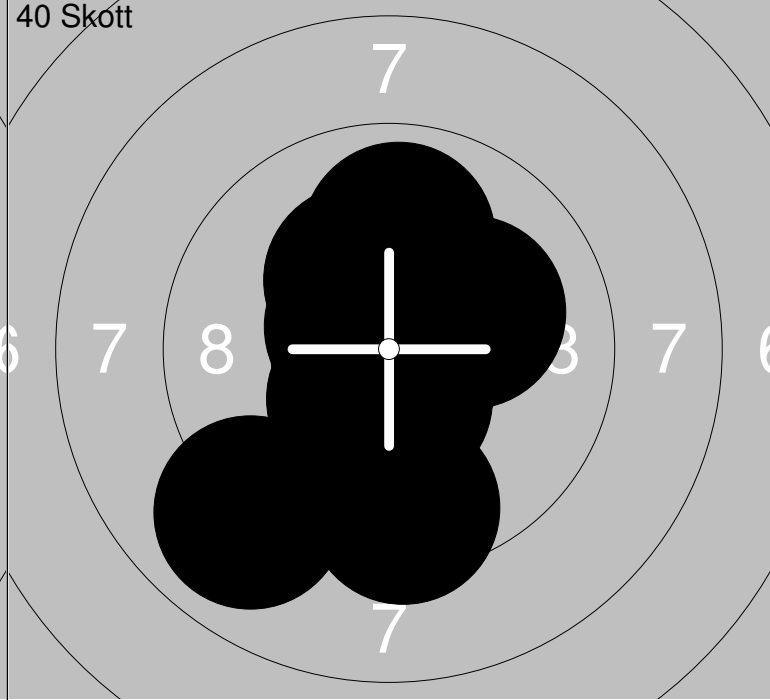
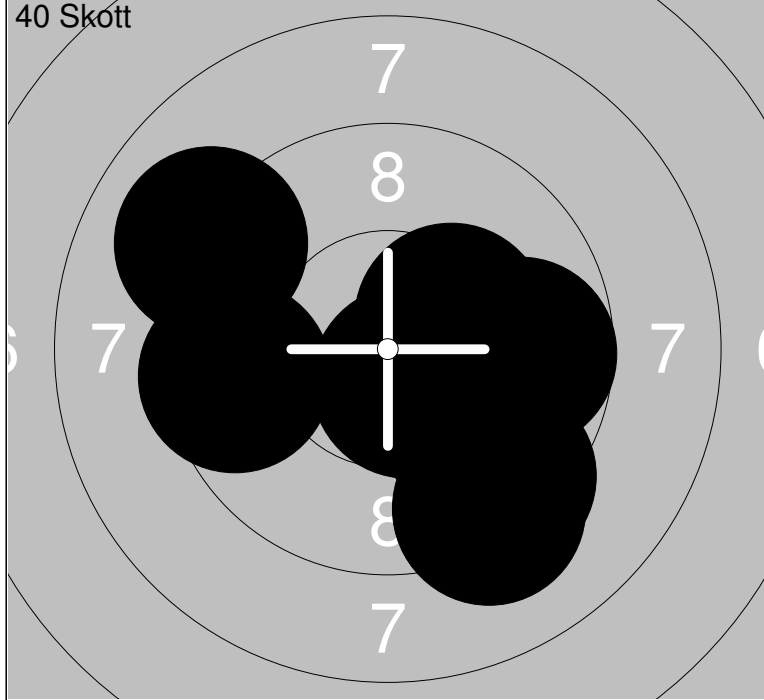

1: 9.2 ↓	6: *10.3 →	Serie	98.5
2: *10.6 ↓	7: 9.5 ←		
3: 9.0 ↗	8: *10.3 ↓	Total	98.5
4: 9.4 ↓	9: *10.6 ↓		
5: 9.7 →	10: 9.9 ↓		

11: 10.1 →	16: *10.8 ↗	Serie	101.4
12: *10.3 ↑	17: *10.5 ↓		
13: *10.4 ↓	18: *10.6 ↖	Total	199.9
14: *10.3 ↖	19: 9.5 ↓		
15: 9.9 ↑	20: 9.0 ↓		

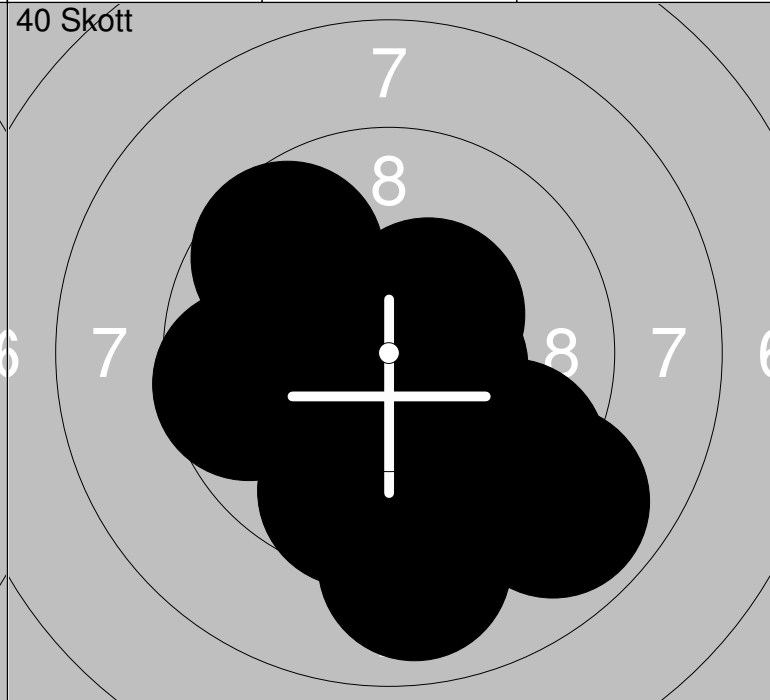
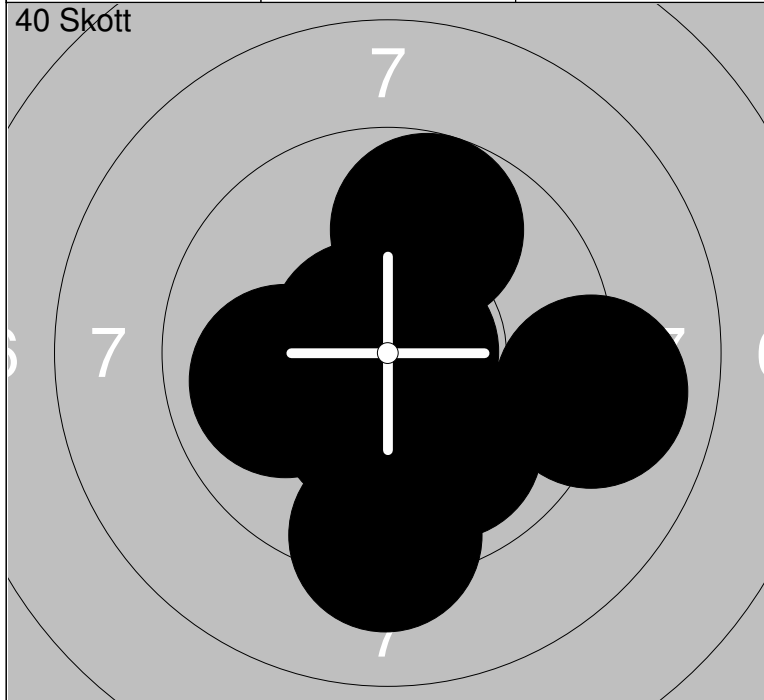

21: 9.3 ↓	26: 10.0 ←	Serie	101.0
22: *10.7 ↖	27: *10.9 ↖		
23: *10.3 ↓	28: 9.7 ↑	Total	300.9
24: *10.3 ↓	29: *10.8 →		
25: 10.0 ↓	30: 9.0 →		

31: *10.4 ↗	36: *10.3 ←	Serie	98.0
32: 9.7 ↖	37: *10.5 ↓		
33: 9.0 ↓	38: 9.6 ←	Total	398.9
34: *10.5 →	39: 9.6 ↓		
35: 9.5 ↓	40: 8.9 ↓		

Skjutlag	Tavla	Johanna Feldt	
9	34		

10m	Trelleborgs SpSk	Dam	
-----	------------------	-----	--

15.03.2013	SM	Jönköpings SG	
------------	----	---------------	--

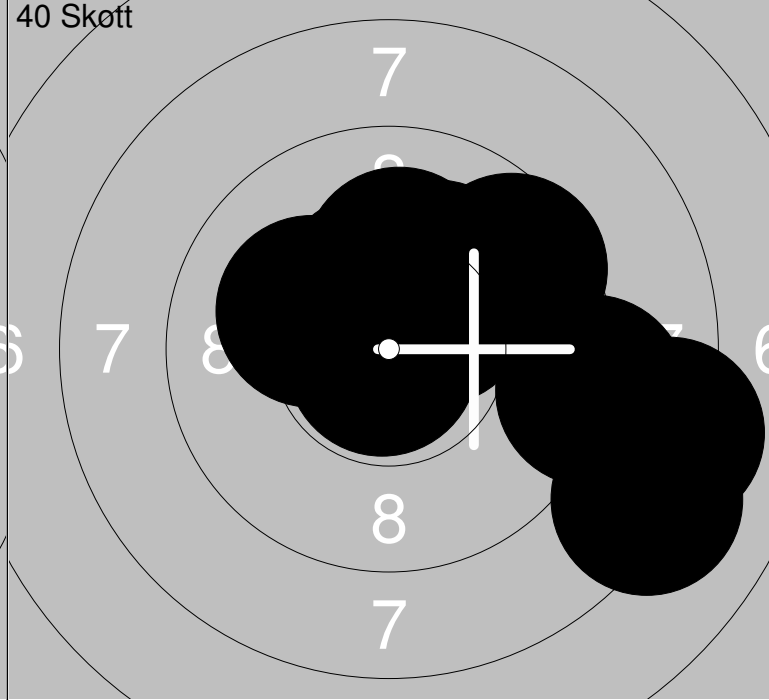
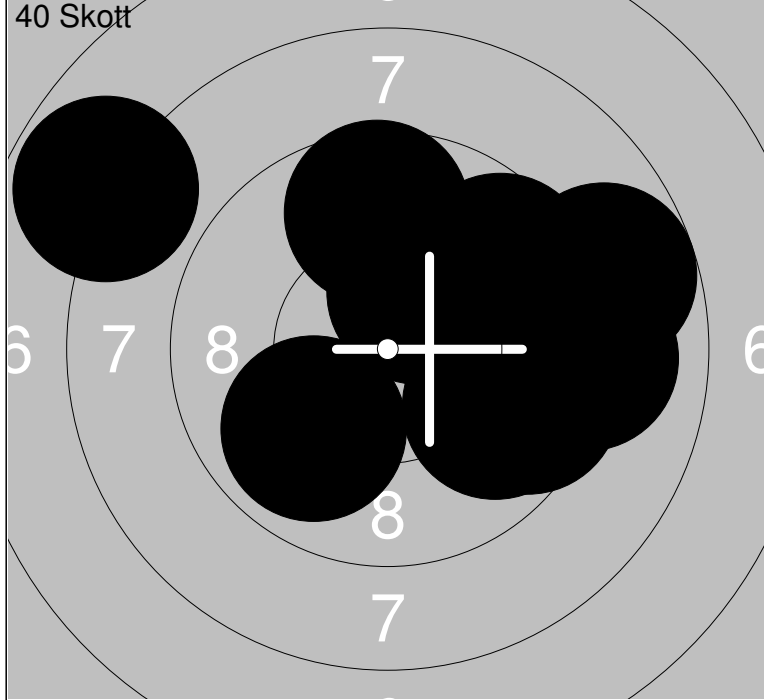

1: 9.9 ↙	6: *10.3 ↗	Serie	93.8
2: 9.0 →	7: 9.5 →		
3: 9.8 ↘	8: 9.6 →	Total	93.8
4: 9.6 ↑	9: 8.7 →		
5: 9.6 ↗	10: 7.8 ↖		

11: 8.1 ↘	16: 9.6 ↗	Serie	96.8
12: *10.4 ↗	17: *10.8 ↘		
13: 10.1 ↑	18: 9.0 →	Total	190.6
14: 10.1 ↗	19: 8.2 →		
15: 10.1 ↖	20: *10.4 ↑		

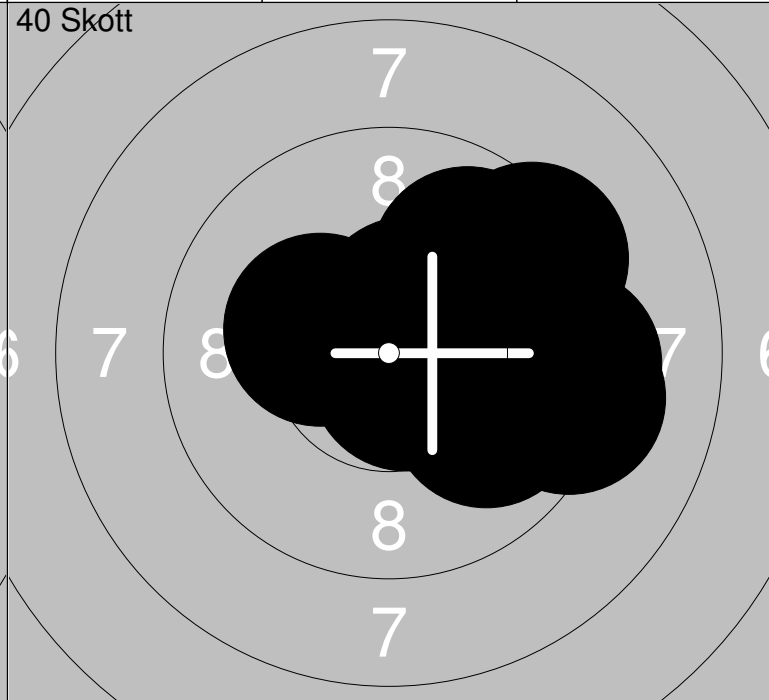
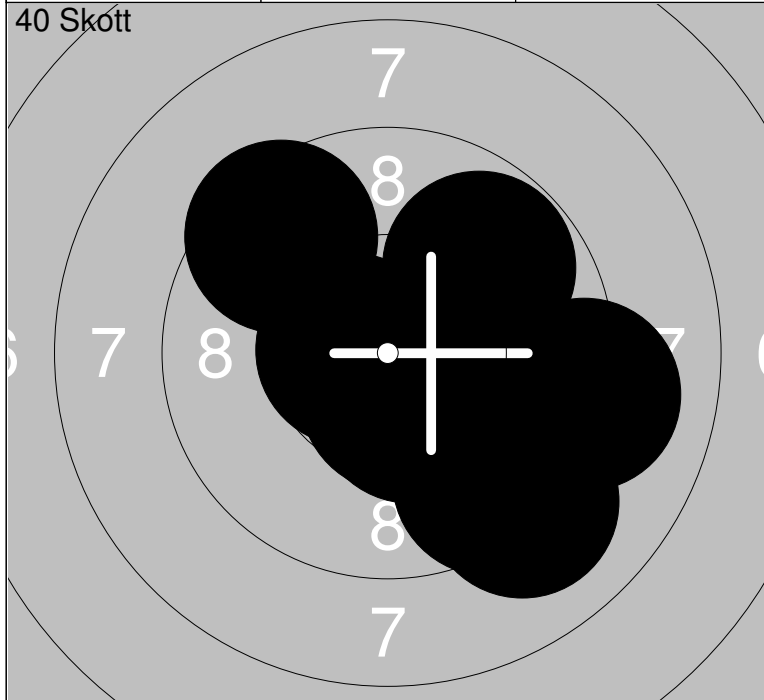

21: 9.1 ↘	26: *10.5 ↓	Serie	98.0
22: 9.4 ↘	27: *10.6 ←		
23: 9.1 →	28: 9.5 ↗	Total	288.6
24: 9.9 ↘	29: 9.8 ↗		
25: *10.4 ↓	30: 9.7 ↘		

31: *10.8 →	36: *10.3 ←	Serie	99.5
32: *10.7 ↘	37: 9.2 →		
33: 9.3 →	38: 9.9 ↘	Total	388.1
34: *10.5 ↗	39: 9.4 ↗		
35: 9.8 ↗	40: 9.6 →		

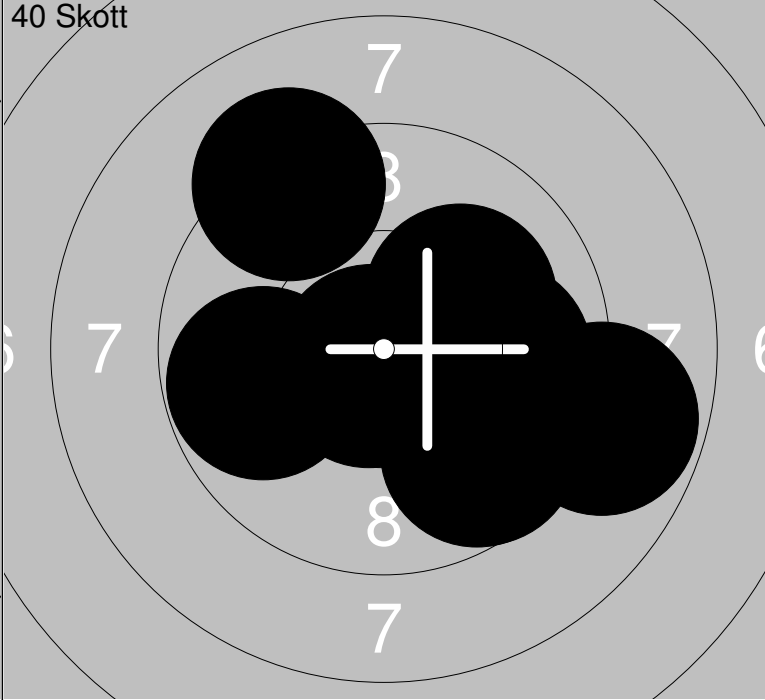
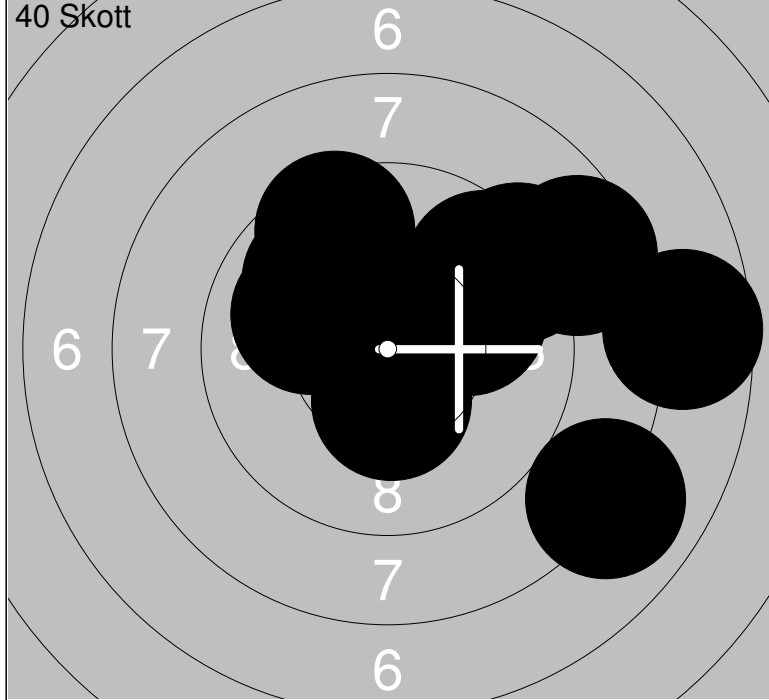

1: 10.0 ↖	6: *10.4 ↓	Serie	92.8
2: 10.0 →	7: 9.5 ↗		
3: 8.0 ↘	8: 9.6 ↗	Total	92.8
4: 9.2 ↗	9: 9.9 ↗		
5: 7.6 →	10: 8.6 ↗		

11: 9.8 ←	16: 8.8 →	Serie	98.8
12: 10.1 →	17: 9.7 ↓		
13: *10.8 ↙	18: 10.1 ↗	Total	191.6
14: 9.9 →	19: 9.7 ↓		
15: *10.7 ↙	20: 9.2 ↗		

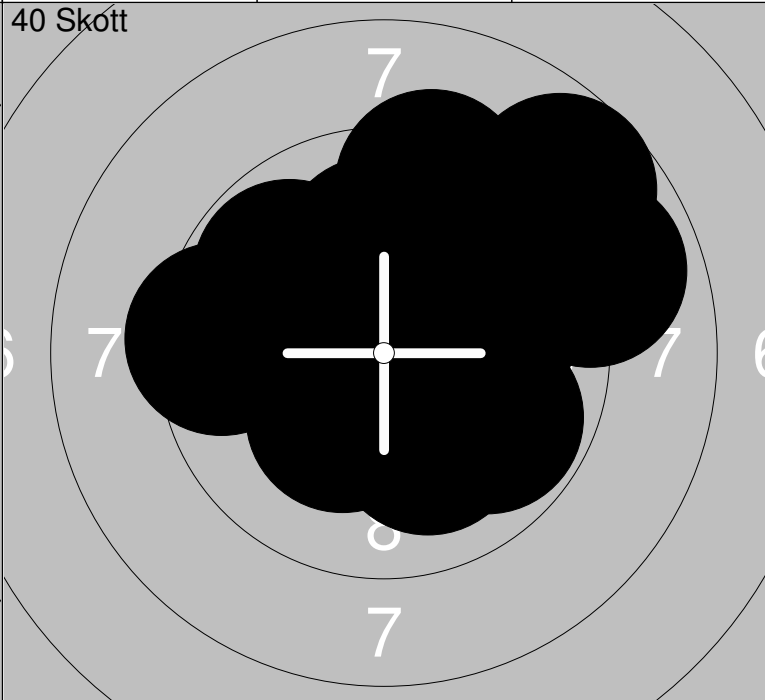
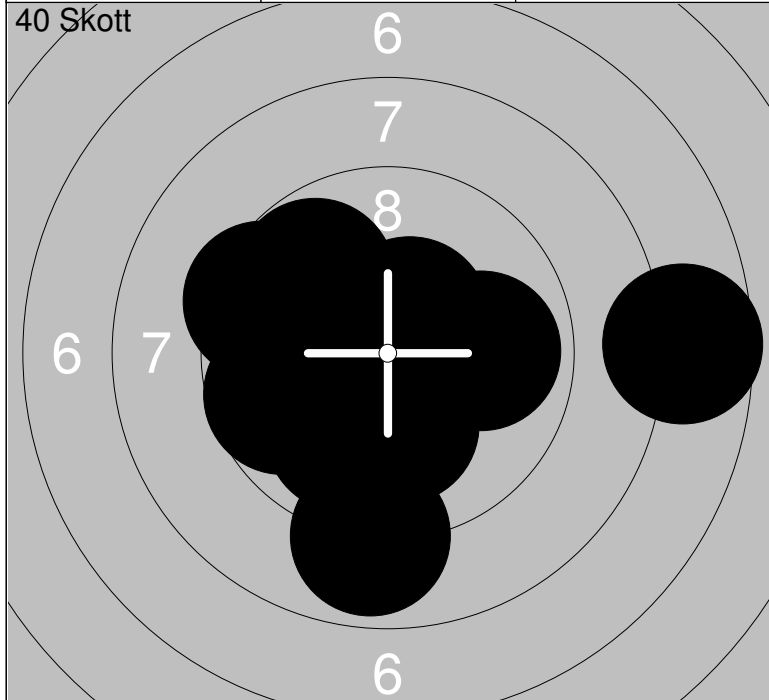

21: 9.8 ↖	26: 7.6 →	Serie	96.4
22: *10.5 ↗	27: 9.7 ←		
23: *10.6 ↖	28: 9.9 →	Total	288.0
24: 9.9 ↙	29: 9.4 ↖		
25: 10.1 ↓	30: 8.9 ↓		

31: 9.8 ↘	36: 10.0 ↑	Serie	96.3
32: 8.9 →	37: 9.4 ←		
33: 10.1 ↓	38: *10.3 ↙	Total	384.3
34: 10.0 →	39: 8.7 ↗		
35: 9.8 ↖	40: 9.3 ↑		

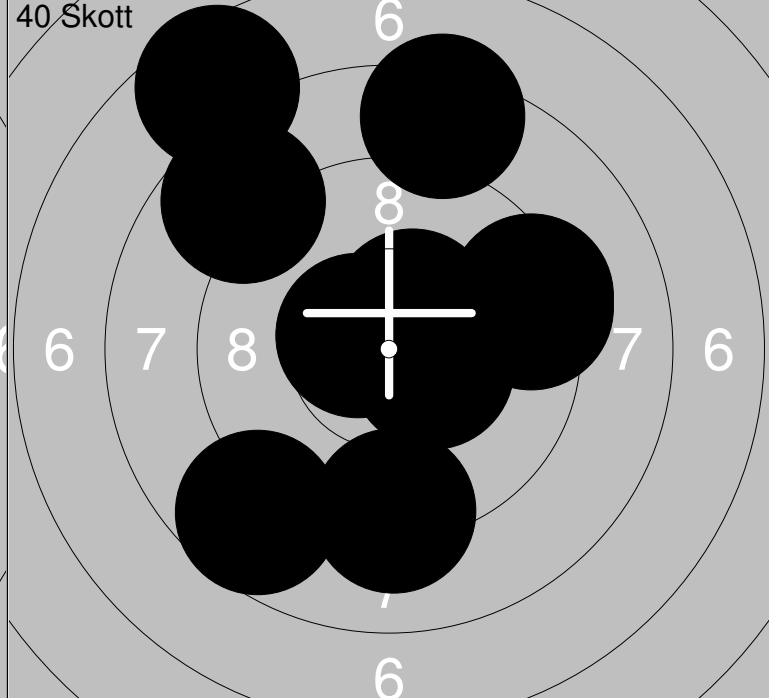
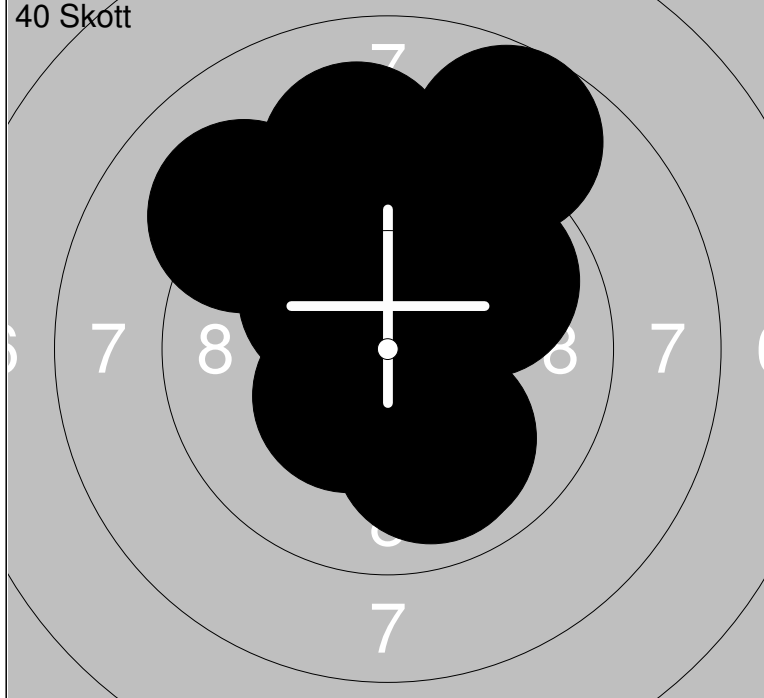

1: 10.0 ↘	6: 9.1 ↗	Serie	97.8
2: 10.1 ↗	7: 10.0 ↘		
3: 9.9 ↗	8: *10.2 ↗	Total	97.8
4: *10.2 ↗	9: 9.2 ↗		
5: *10.4 ↘	10: 8.7 ↗		

11: *10.6 ↖	16: 9.3 →	Serie	92.5
12: 9.2 ↘	17: 9.3 →		
13: 8.7 ↗	18: 8.7 ↘	Total	190.3
14: *10.4 →	19: 8.3 ↗		
15: *10.5 ↗	20: 7.5 ↗		

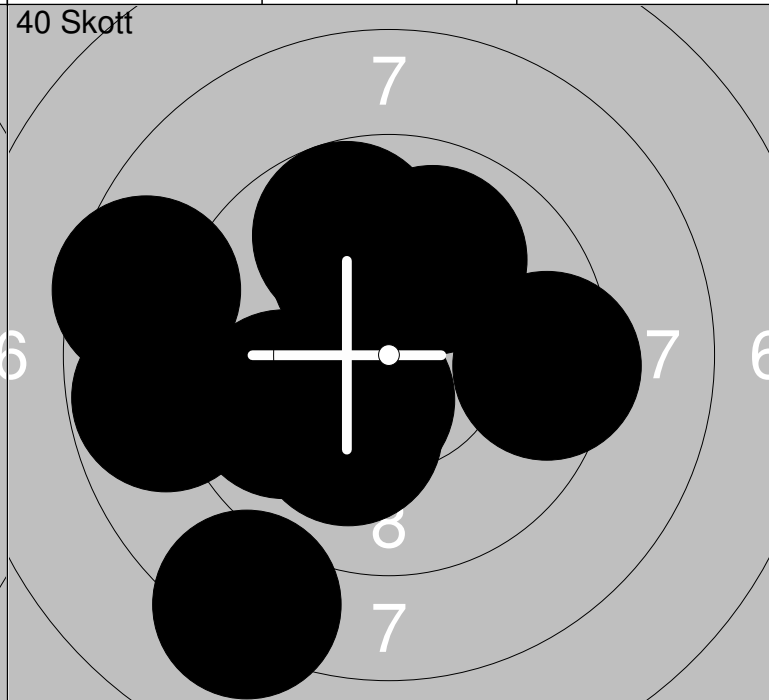
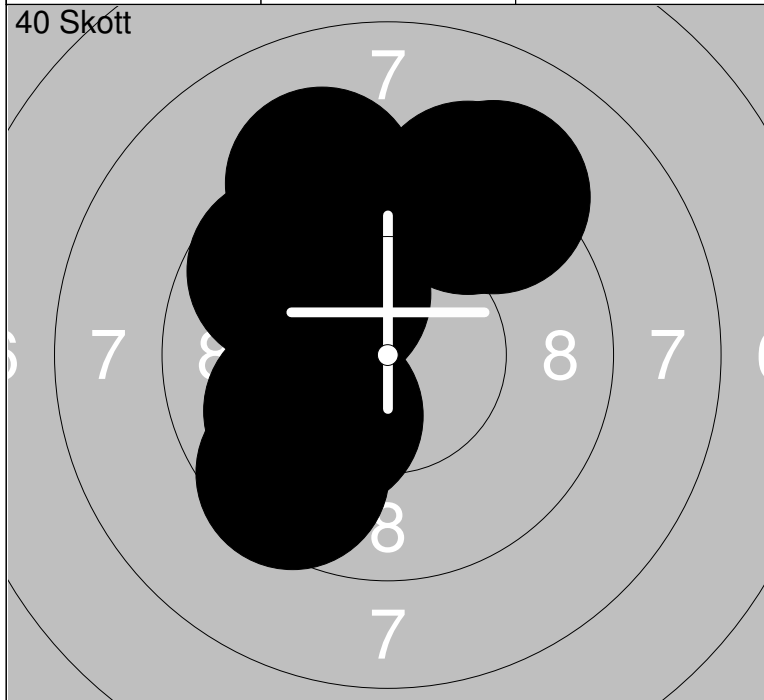

21: 10.0 ↖	26: *10.2 ↘	Serie	96.9
22: 9.7 ↖	27: 9.2 ↗		
23: 10.0 ↗	28: 9.2 ↗	Total	287.2
24: *10.2 ↗	29: 9.6 ↗		
25: 9.3 ↗	30: 9.5 ↘		

31: 9.4 →	36: 8.6 ↖	Serie	95.2
32: 9.7 ↗	37: *10.4 ↘		
33: 10.1 ↘	38: 10.1 ↗	Total	382.4
34: 8.8 ↖	39: 10.0 ↗		
35: 8.2 ↘	40: 9.9 ↖		

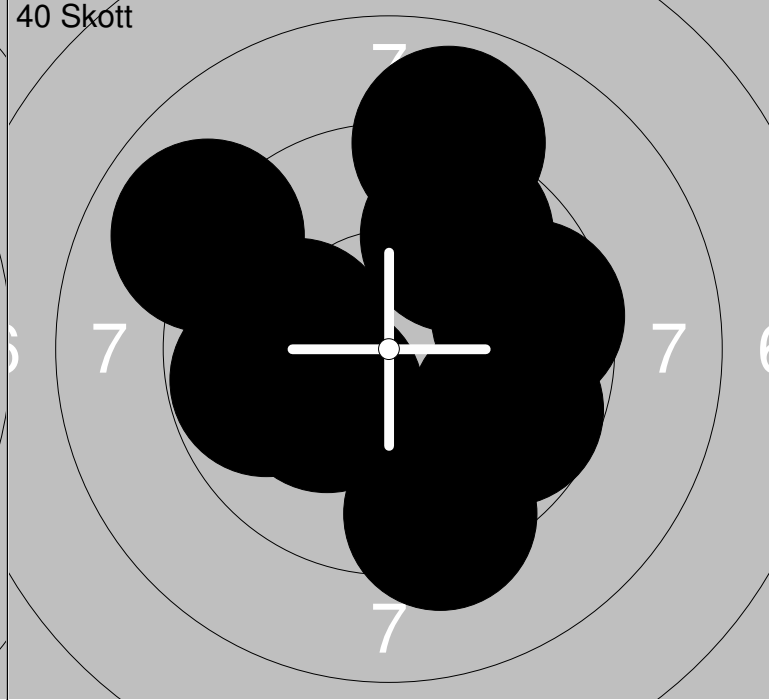
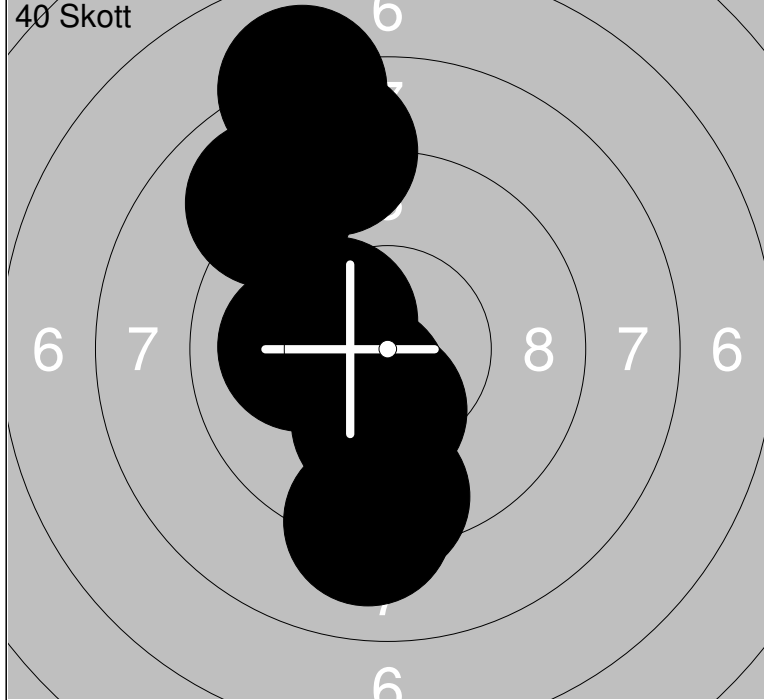

1: 9.4 ↓	6: *10.3 ↙	Serie	95.7
2: *10.2 ↓	7: *10.5 ↓		
3: 9.1 ↓	8: 9.0 ↗	Total	95.7
4: *10.3 ↓	9: 8.8 ↑		
5: 8.1 ↑	10: 10.0 ←		

11: 9.0 ↖	16: 9.3 ↓	Serie	96.4
12: 9.0 ↑	17: 10.1 ←		
13: 9.8 ←	18: 9.6 →	Total	192.1
14: 9.7 ↗	19: 9.7 ↘		
15: *10.2 ↙	20: 10.0 ←		

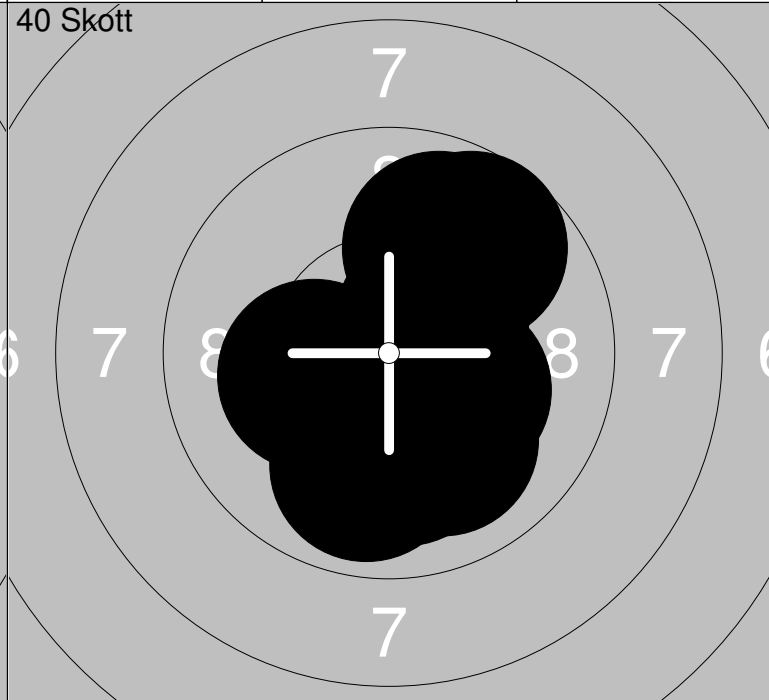
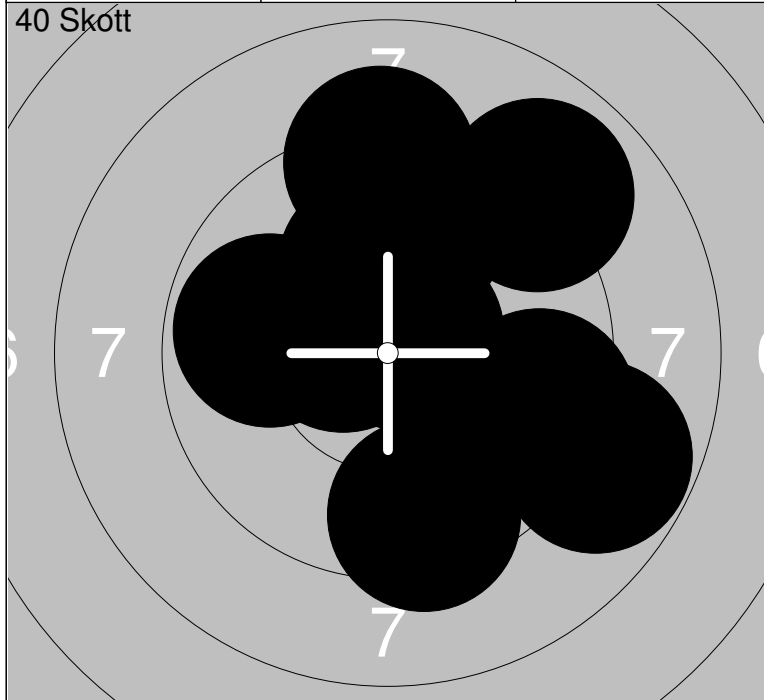

21: 9.4 ↓	26: 8.9 ↗	Serie	96.8
22: 9.5 →	27: *10.2 ↑		
23: 9.8 ↑	28: *10.7 ↗	Total	288.9
24: 8.8 →	29: 9.2 ↑		
25: 9.8 ←	30: *10.5 ↙		

31: *10.5 ↗	36: 10.0 ↓	Serie	101.6
32: 9.7 ↗	37: *10.6 →		
33: *10.6 →	38: 9.9 ↓	Total	390.5
34: *10.2 ←	39: 9.9 ↑		
35: 10.0 ↓	40: *10.2 ↘		

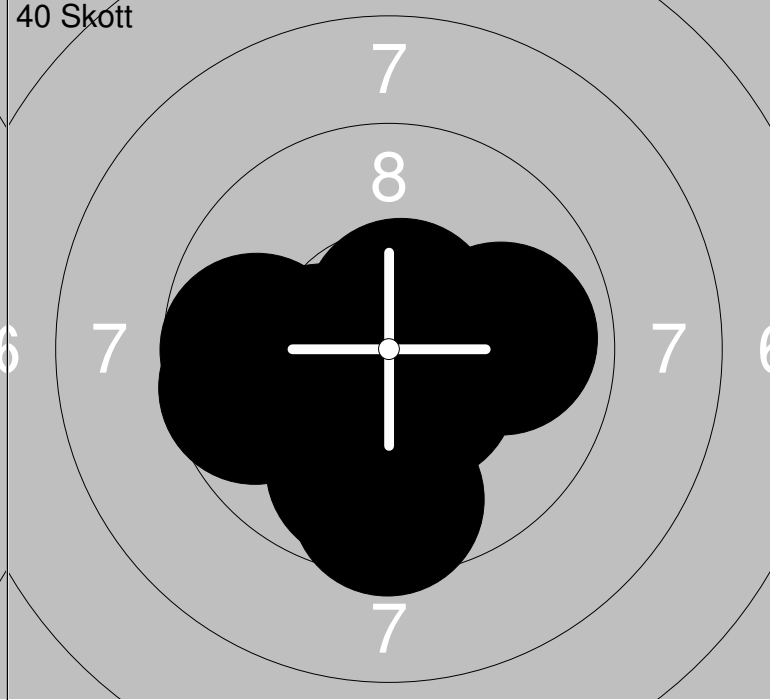
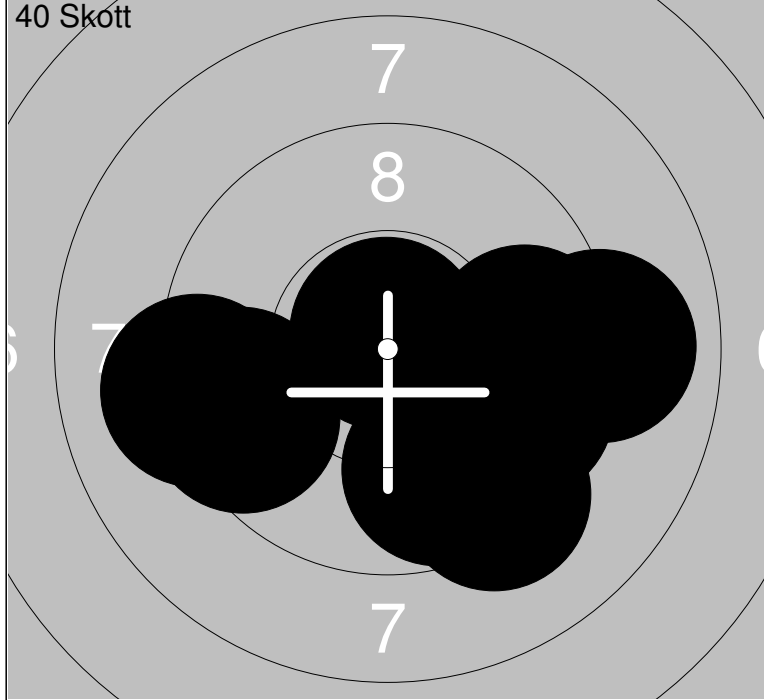

1: *10.8 ↑	6: 9.1 ←	Serie	95.8
2: 9.6 →	7: 9.3 ↓		
3: 9.7 ↓	8: 9.0 →	Total	95.8
4: 9.7 →	9: 9.5 ←		
5: 9.6 ↘	10: 9.5 ←		

11: 9.7 ←	16: *10.3 ←	Serie	100.7
12: 9.7 ←	17: *10.3 ↓		
13: 9.9 →	18: *10.6 ↑	Total	196.5
14: 9.8 ↓	19: 9.5 ↓		
15: *10.4 ←	20: *10.5 ↓		

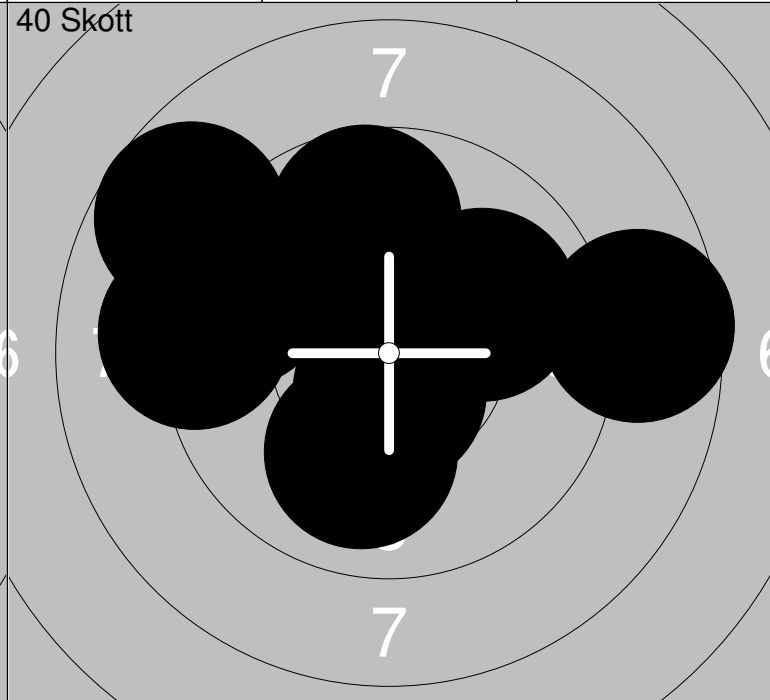
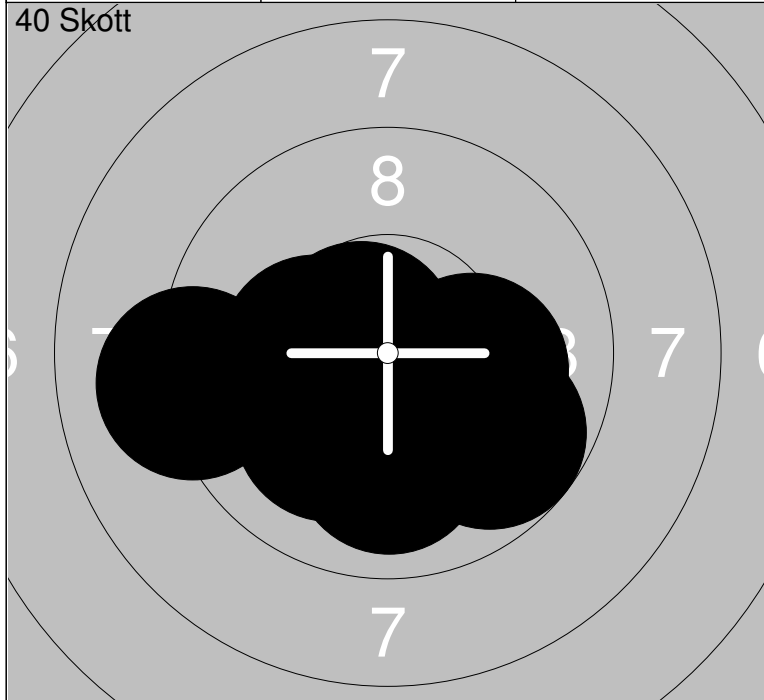

21: 10.0 ←	26: 9.7 ↓	Serie	100.4
22: 10.1 ↓	27: 10.1 ↓		
23: 9.1 ←	28: *10.2 →	Total	296.9
24: 10.0 ↓	29: *10.3 ←		
25: *10.2 ↘	30: *10.7 ↖		

31: 10.0 ↓	36: 9.7 ↑	Serie	97.3
32: 10.0 →	37: 8.7 ←		
33: 8.6 →	38: 9.4 ←	Total	394.2
34: *10.8 ↑	39: 9.1 ←		
35: *10.4 ↑	40: *10.6 ↓		



Skjutlag	Tavla	Marika Jensen	
9	40		

10m	Trelleborgs SpSk	Dam	
-----	------------------	-----	--

15.03.2013	SM	Jönköpings SG	
------------	----	---------------	--

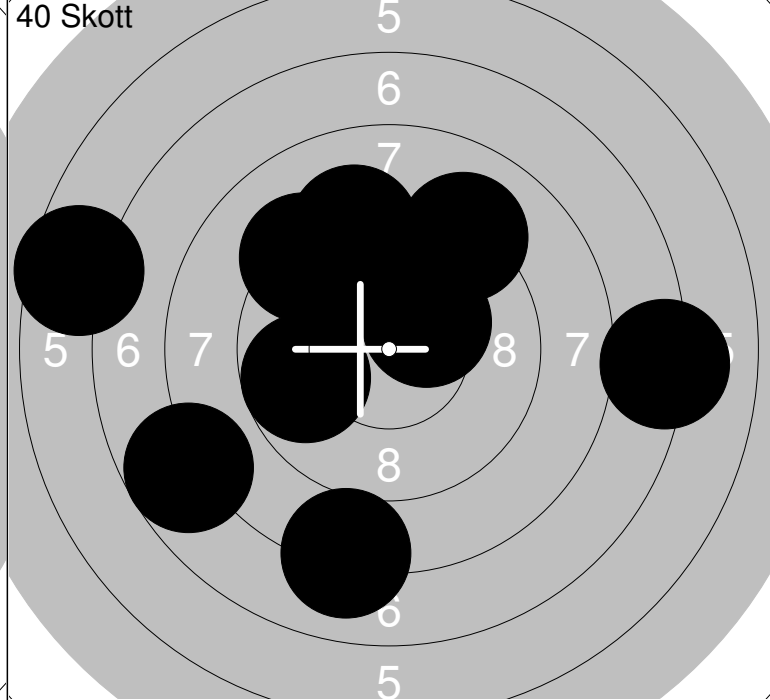
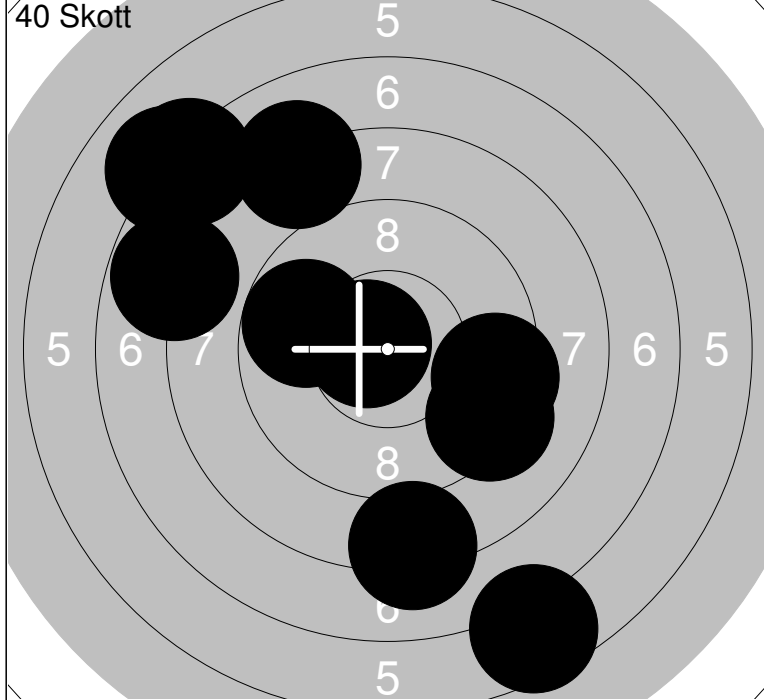

1: 6.5 ↘	6: 9.4 →	Serie	83.8
2: 7.0 ↗	7: 8.2 ↓		
3: 9.8 ↖	8: 7.8 ←	Total	83.8
4: 9.2 ↘	9: *10.7 ←		
5: 8.1 ↗	10: 7.1 ↗		

11: 9.2 ↖	16: 8.1 ↓	Serie	86.6
12: 7.1 →	17: 9.1 ↗		
13: 7.7 ↙	18: 9.2 ↑	Total	170.4
14: 6.5 ←	19: *10.3 ↗		
15: 9.7 ↗	20: 9.7 ←		

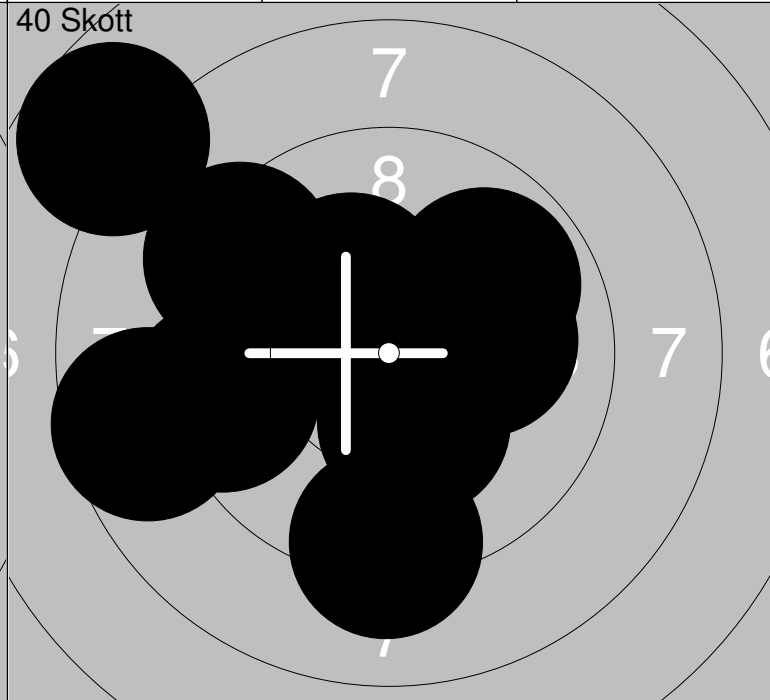
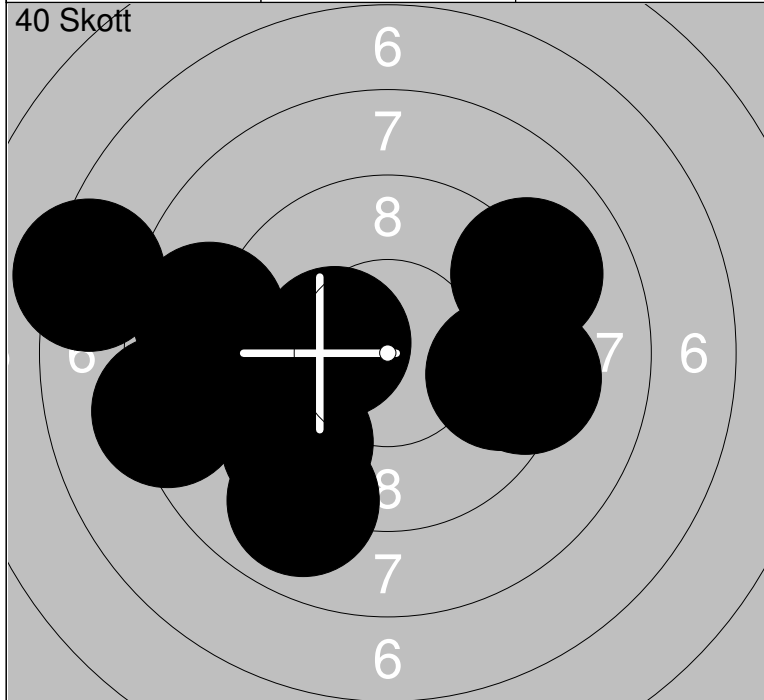

21: 7.3 ←	26: 9.3 →	Serie	90.3
22: 8.8 ←	27: 8.3 ←		
23: 9.5 ↙	28: 9.0 ↓	Total	260.7
24: *10.3 ←	29: 9.6 →		
25: 9.1 ←	30: 9.1 ↗		

31: 9.2 ↓	36: *10.3 ↖	Serie	95.3
32: *10.5 ↖	37: 9.9 ↗		
33: 7.7 ↖	38: 8.6 ←	Total	356.0
34: *10.3 ↓	39: 9.3 ↖		
35: 10.1 →	40: 9.4 ←		