

1: 10.0 ↓	6: *10.9 ↗	Serie	101.2
2: 9.3 ↓	7: *10.4 ↓		
3: 9.6 ↓	8: *10.5 ↘	Total	101.2
4: 9.5 ↙	9: *10.6 ↓		
5: 10.0 ↓	10: *10.4 ↑		

11: 10.0 ↙	16: 8.8 ←	Serie	98.8
12: *10.2 ↑	17: *10.4 ←		
13: *10.2 ↘	18: 9.9 ↓	Total	200.0
14: 10.1 ←	19: *10.5 ↙		
15: 9.8 ↓	20: 8.9 ←		

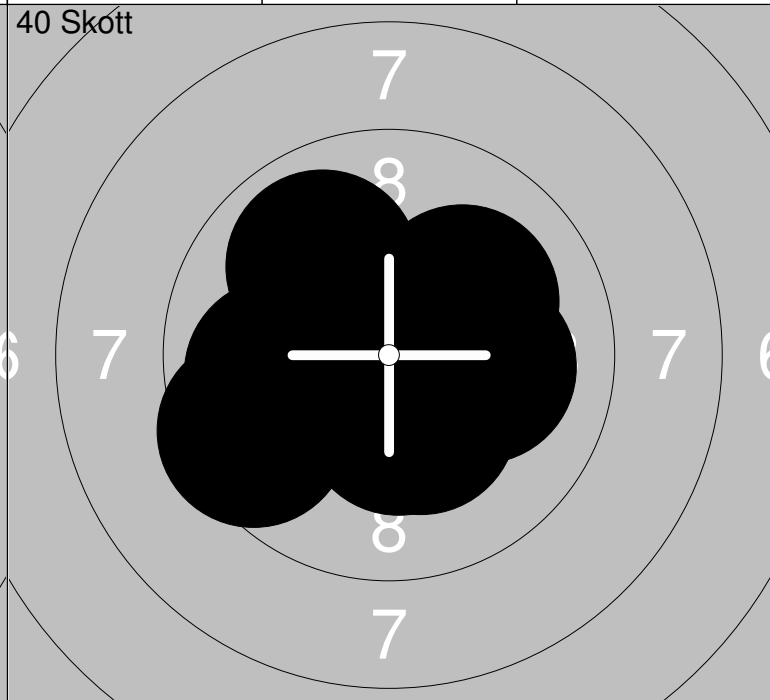
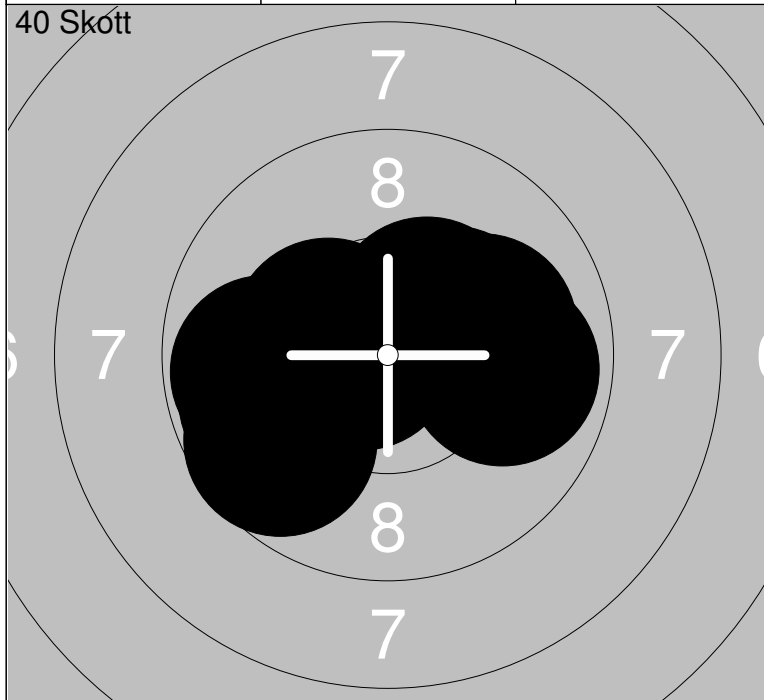

21: 9.9 →	26: *10.7 ←	Serie	101.6
22: *10.5 ←	27: 9.7 ↙		
23: *10.4 ←	28: *10.3 ↗	Total	301.6
24: 9.8 ←	29: *10.4 ↗		
25: 9.8 ←	30: 10.1 →		

31: *10.5 →	36: 10.1 →	Serie	101.6
32: *10.3 ↓	37: 9.5 ↙		
33: *10.4 ↓	38: 10.1 ↗	Total	403.2
34: *10.4 ↓	39: 9.9 ↗		
35: *10.5 ↙	40: 9.9 ←		

Skjutlag	Tavla	Hanna Karlsson	
9	22		

10m	Ramselefors SF	Dam	
-----	----------------	-----	--

15.03.2013	SM	Jönköpings SG	
------------	----	---------------	--

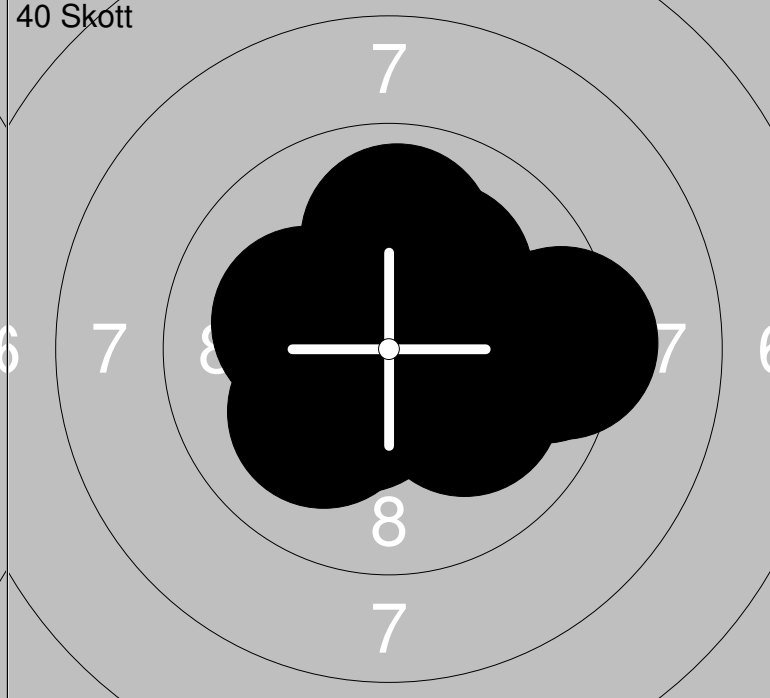
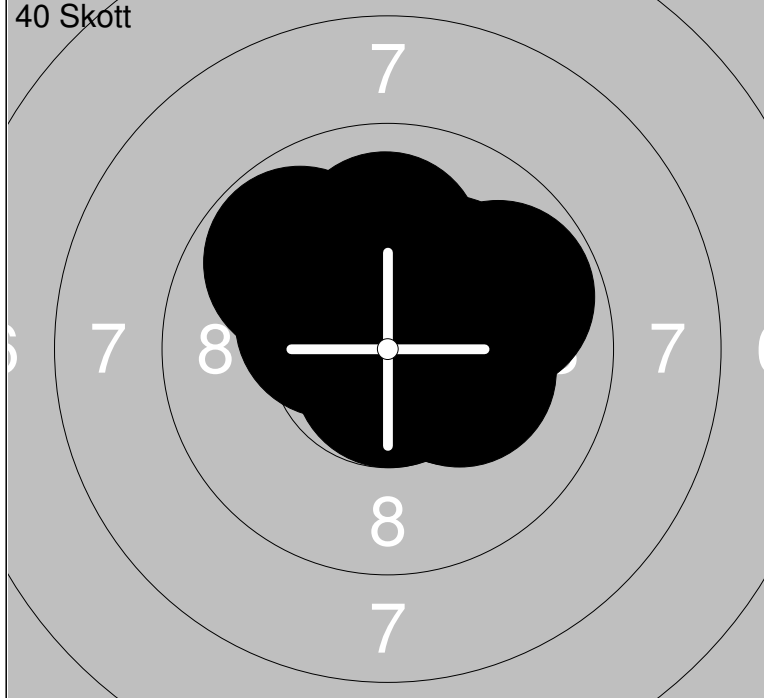

1: 9.8 ↙	6: *10.6 ↑	Serie	102.1
2: *10.7 ↓	7: 9.8 ↗		
3: 10.0 ↑	8: *10.3 →	Total	102.1
4: 10.0 ↗	9: *10.3 →		
5: *10.2 ↗	10: *10.4 ↙		

11: *10.8 ←	16: 9.3 →	Serie	101.0
12: *10.4 ↓	17: 9.9 ↑		
13: 10.1 ↘	18: *10.2 ↗	Total	203.1
14: 9.5 →	19: *10.2 ←		
15: *10.5 →	20: 10.1 ↙		

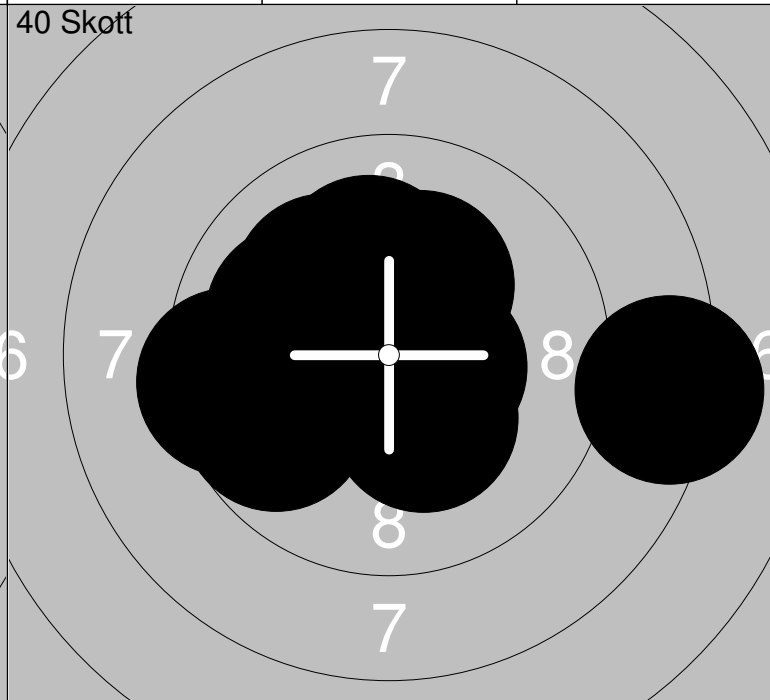
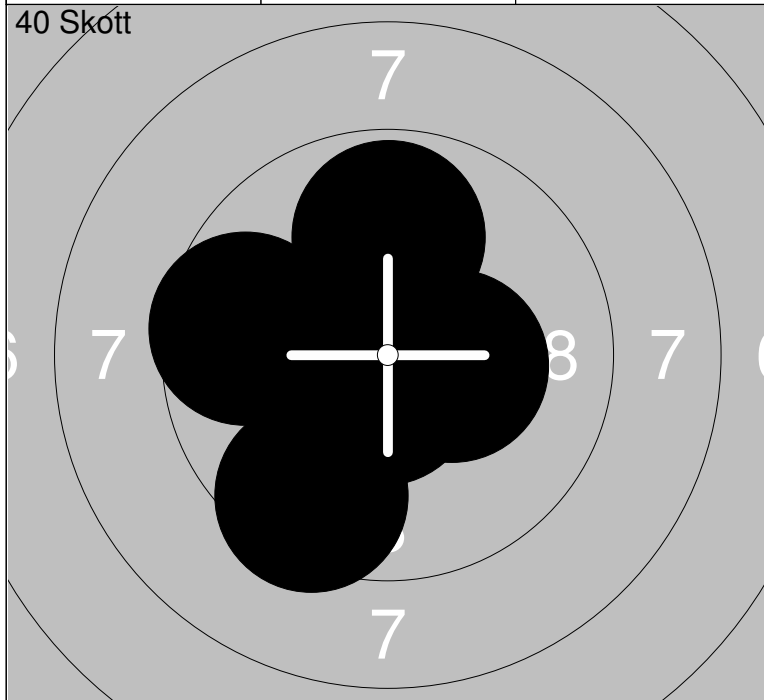

21: *10.7 ↓	26: *10.7 ↓	Serie	103.4
22: 9.9 ↑	27: 9.5 ↓		
23: *10.3 →	28: 9.6 ←	Total	306.5
24: *10.9 ↗	29: *10.9 ↓		
25: *10.6 ↓	30: *10.3 ←		

31: 9.4 ←	36: *10.3 ↓	Serie	99.1
32: 10.1 ↙	37: *10.5 ↓		
33: 8.3 →	38: 10.0 ←	Total	405.6
34: 9.7 ←	39: *10.2 ↑		
35: *10.5 →	40: 10.1 ↑		

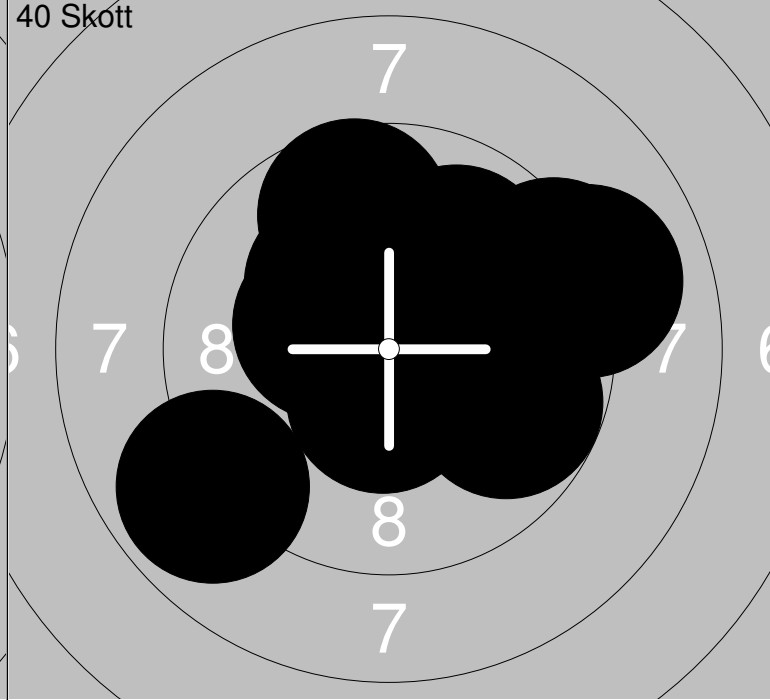
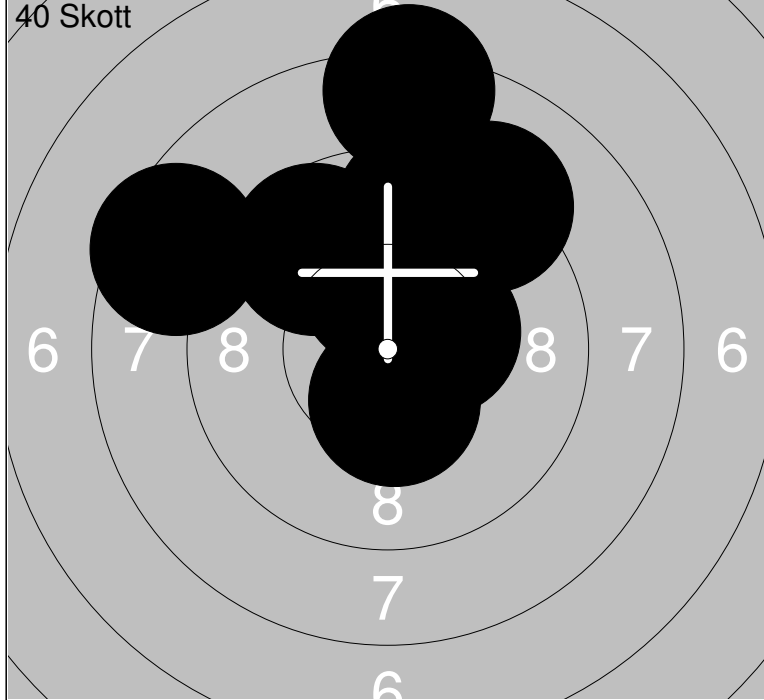

1: *10.5 ↗	6: *10.3 ↑	Serie	96.9
2: 9.1 ↗	7: *10.3 ↑		
3: 9.7 ↖	8: *10.4 ↓	Total	96.9
4: 8.5 ↖	9: 9.5 ↑		
5: 8.2 ↑	10: *10.4 →		

11: *10.3 ↖	16: *10.3 →	Serie	97.9
12: 9.9 ↗	17: *10.2 ↖		
13: 9.0 →	18: 9.8 →	Total	194.8
14: *10.5 ↓	19: 8.9 ↖		
15: 9.3 →	20: 9.7 ↑		

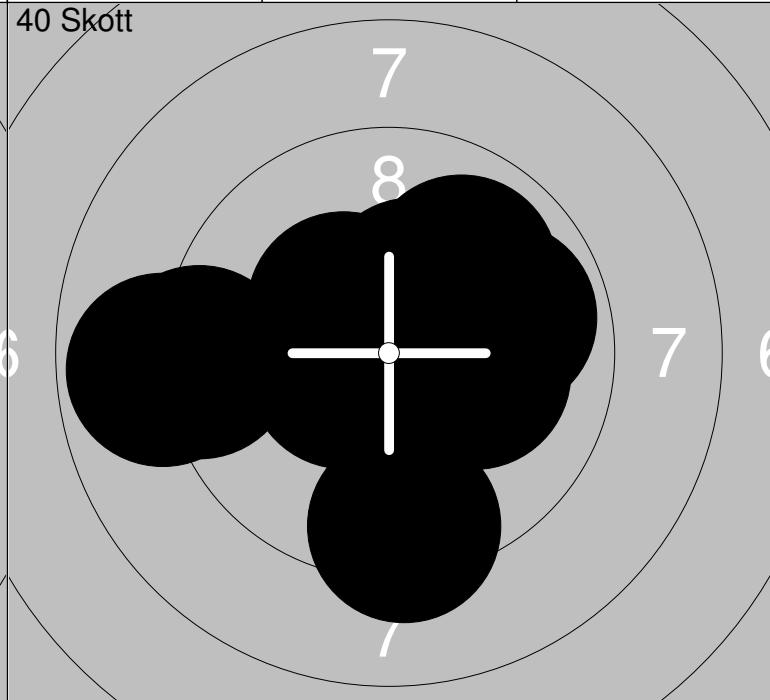
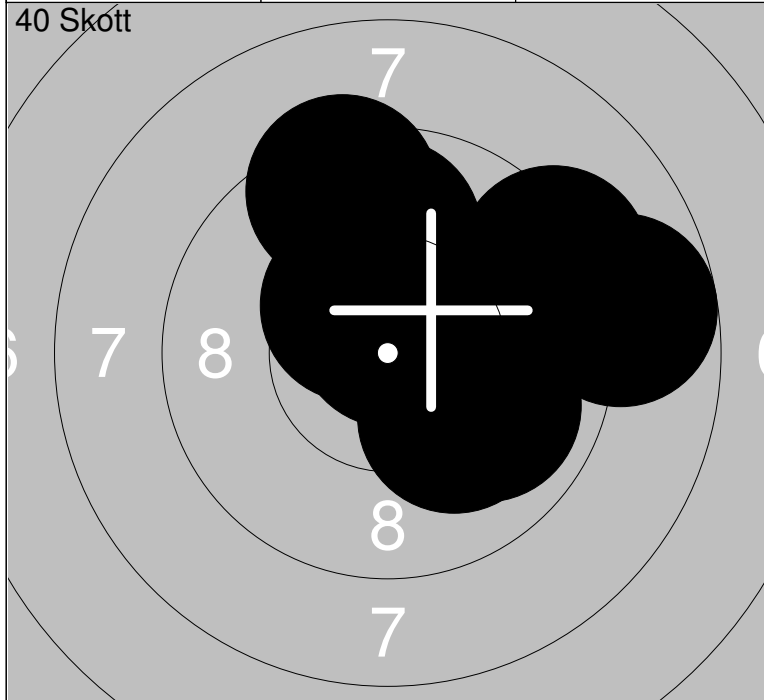

21: 9.4 ↑	26: 9.2 →	Serie	98.9
22: 9.9 ↘	27: *10.4 ↖		
23: *10.7 ↑	28: *10.3 ↑	Total	293.7
24: 9.8 ↑	29: *10.4 ↑		
25: 10.1 ↘	30: 8.7 →		

31: 10.1 →	36: *10.5 ↖	Serie	99.4
32: 8.8 ←	37: 9.3 ↓		
33: 9.2 ←	38: *10.9 ↑	Total	393.1
34: *10.4 ↑	39: 9.9 →		
35: 9.9 ↗	40: *10.4 ↖		

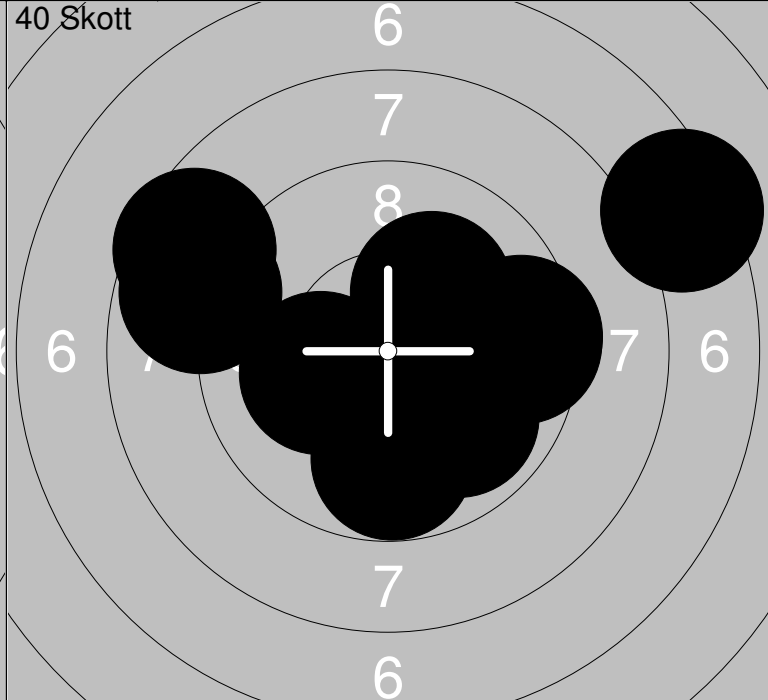
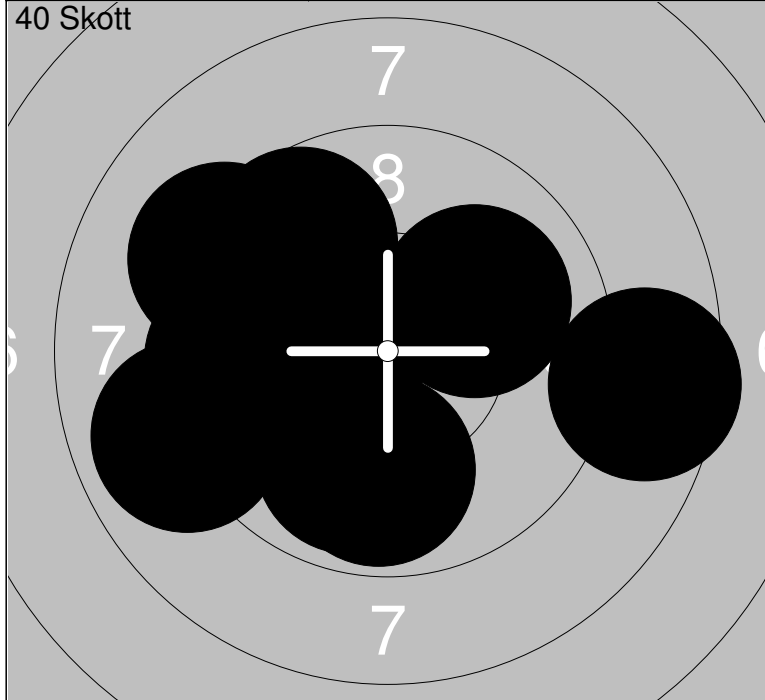

1: 9.2 ↖	6: 9.7 ↗	Serie	96.2
2: 8.9 ↙	7: *10.3 ↙		
3: 9.8 ↓	8: 9.9 ↓	Total	96.2
4: 8.5 →	9: 10.0 ↗		
5: *10.3 ↙	10: 9.6 ←		

11: 9.9 ↘	16: 9.5 →	Serie	93.7
12: 9.8 ↓	17: *10.2 ↙		
13: 9.9 ↓	18: 8.8 ←	Total	189.9
14: 7.4 ↗	19: 8.5 ↙		
15: *10.2 ↗	20: 9.5 →		

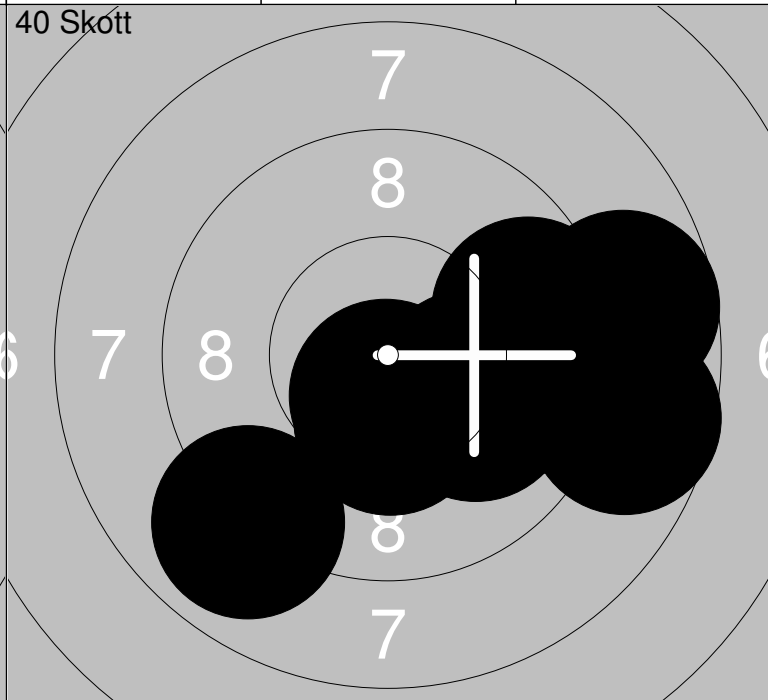
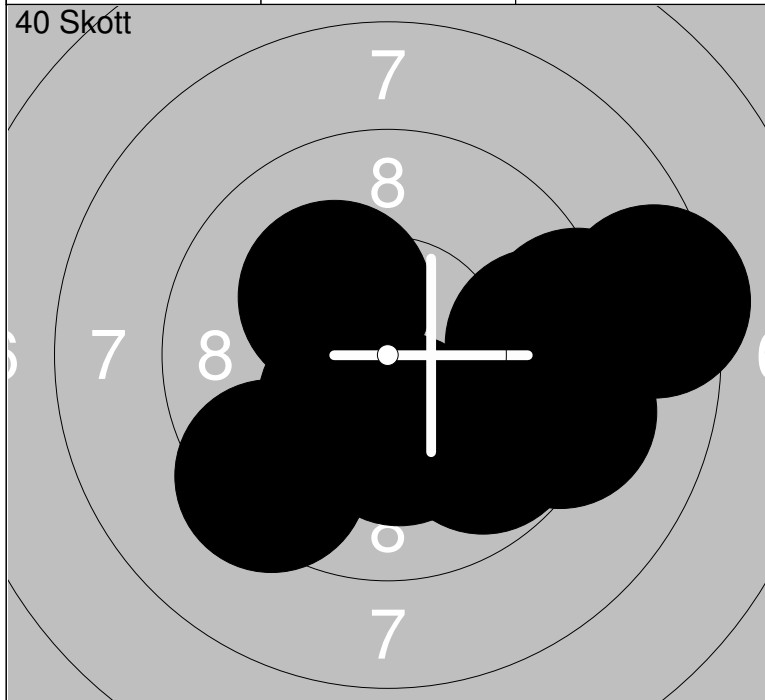

21: *10.4 ↙	26: 9.8 ↘	Serie	96.9
22: 9.5 →	27: 8.4 →		
23: *10.2 ↖	28: 9.3 →	Total	286.8
24: 9.4 ↙	29: 9.2 →		
25: *10.3 ↓	30: *10.4 ↙		

31: 9.6 →	36: 10.1 →	Serie	96.3
32: 8.7 →	37: *10.4 ↓		
33: 9.5 →	38: 8.9 ↙	Total	383.1
34: 8.7 →	39: 10.0 →		
35: 9.8 →	40: *10.6 ↓		

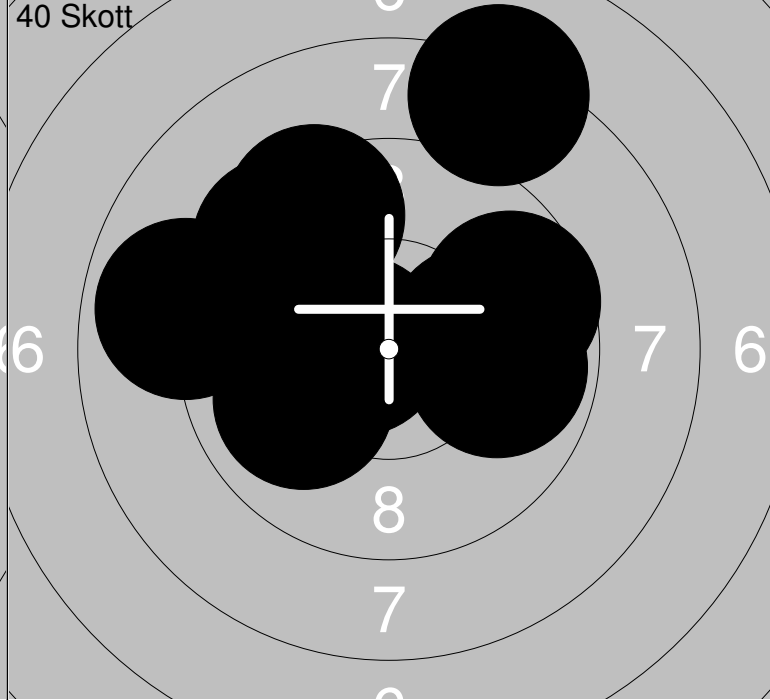
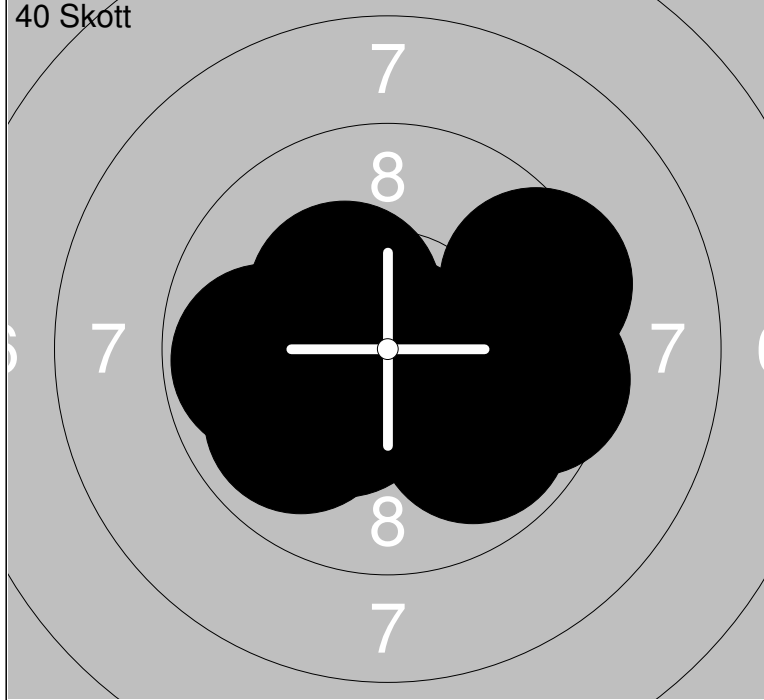

1: *10.9 ↘	6: *10.9 ↙	Serie	101.5
2: 9.9 ↙	7: *10.3 ↗		
3: 9.6 →	8: 9.9 ↘	Total	101.5
4: 9.4 →	9: 9.8 ←		
5: *10.5 ↙	10: *10.3 ↙		

11: 9.5 ←	16: 10.1 →	Serie	95.8
12: 9.9 →	17: 8.9 ←		
13: *10.6 ←	18: 10.0 ←	Total	197.3
14: 9.4 ↗	19: 9.5 ↗		
15: 8.2 ↗	20: 9.7 →		

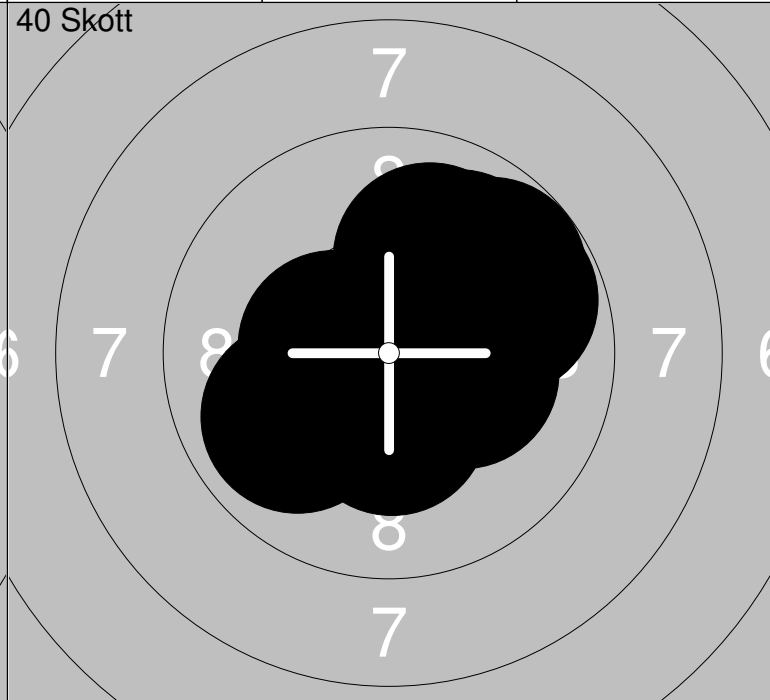
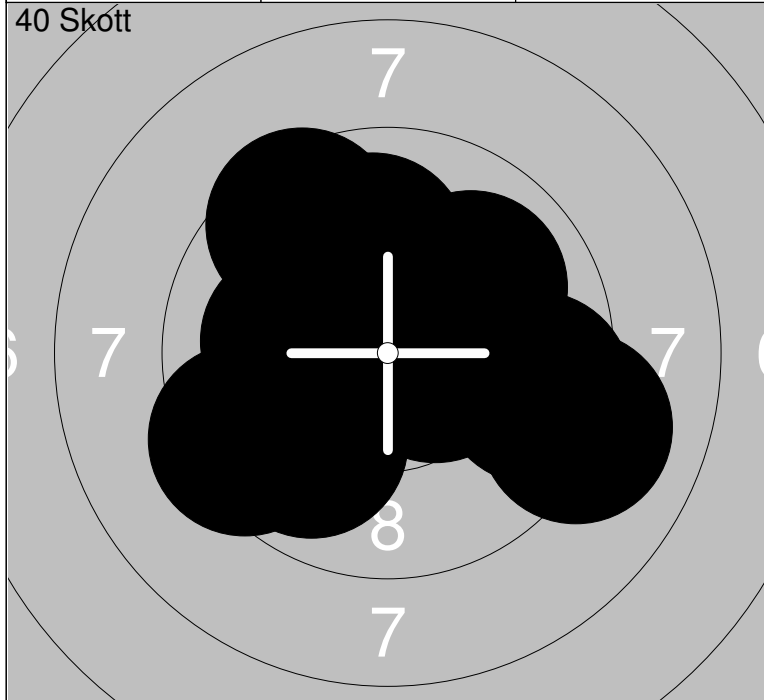

21: *10.5 →	26: *10.4 ↗	Serie	98.4
22: 9.5 →	27: 10.0 ↗		
23: 10.1 ←	28: 9.9 ↙	Total	295.7
24: 9.5 ↗	29: 9.4 ←		
25: 9.1 →	30: 10.0 ↗		

31: *10.3 ↓	36: *10.9 ↗	Serie	102.0
32: 9.9 ↗	37: 9.8 →		
33: 9.8 ↗	38: 9.9 ←	Total	397.7
34: *10.4 ←	39: 10.0 ↗		
35: *10.2 →	40: *10.8 ↓		

Skjutlag	Tavla	Johanna Nilsson	
9	26		

10m	Ramselefors SF	Dam	
-----	----------------	-----	--

15.03.2013	SM	Jönköpings SG	
------------	----	---------------	--

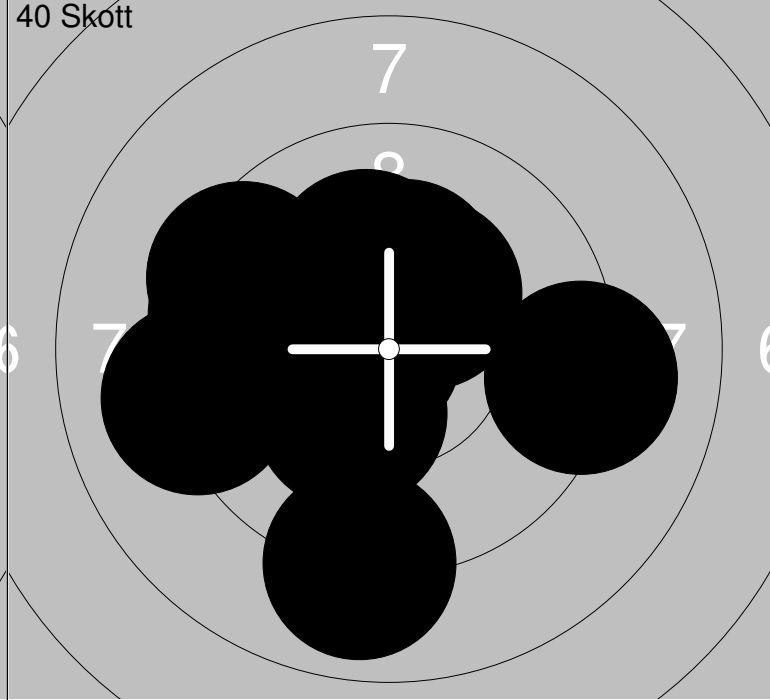
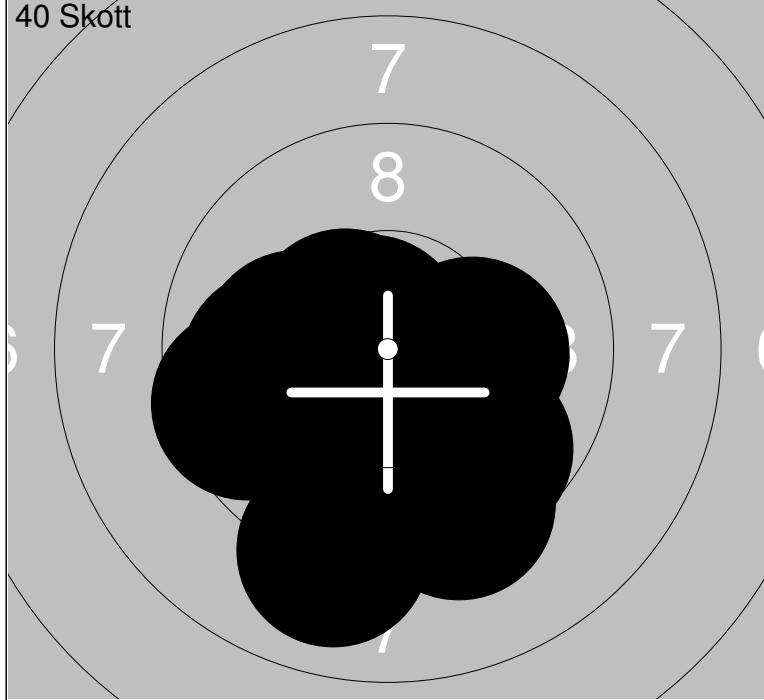

1: 9.9 ←	6: 9.7 ↘	Serie	99.8
2: 10.1 ←	7: *10.7 ↗		
3: *10.7 ↓	8: *10.2 →	Total	99.8
4: 9.0 ↓	9: 9.6 ←		
5: 9.4 ↓	10: *10.5 ↘		

11: 9.1 ←	16: 9.4 ←	Serie	97.8
12: *10.3 ↗	17: *10.7 ←		
13: 8.9 ↓	18: 10.1 ↑	Total	197.6
14: 9.6 ←	19: 9.1 →		
15: *10.3 ↘	20: *10.3 ↑		

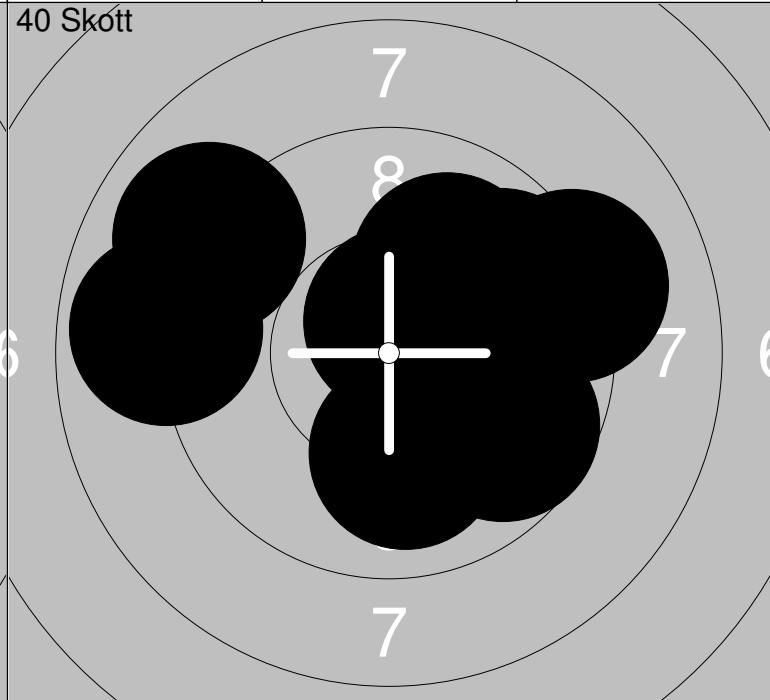
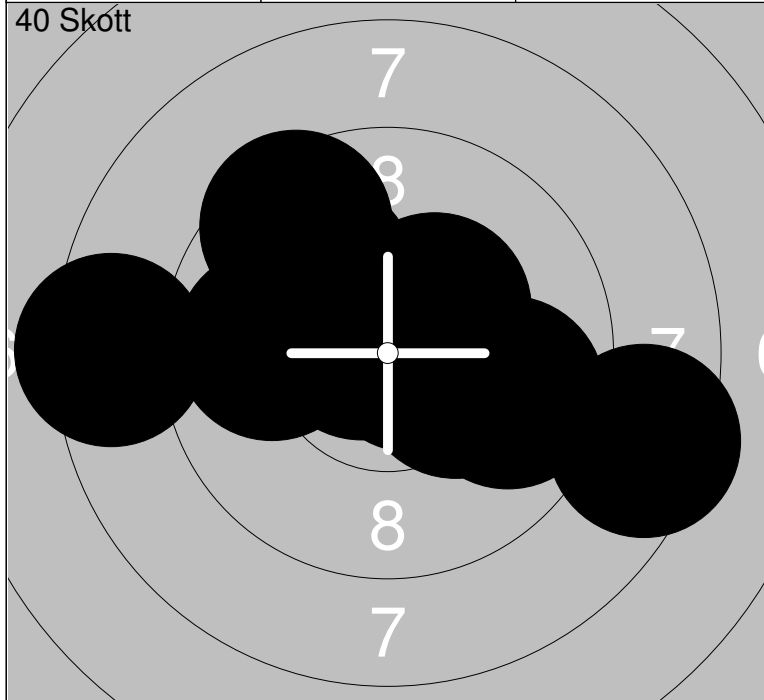

21: 9.8 →	26: *10.3 ↘	Serie	98.1
22: 9.9 ←	27: 10.0 ↗		
23: 8.4 ←	28: 8.4 →	Total	295.7
24: *10.7 ←	29: *10.4 ↗		
25: *10.7 →	30: 9.5 ↗		

31: 10.0 ↓	36: 10.1 →	Serie	97.6
32: 9.7 ↗	37: 10.0 ↗		
33: 9.1 ↗	38: *10.6 ↑	Total	393.3
34: *10.5 →	39: 8.9 ←		
35: 9.0 ←	40: 9.7 ↘		

Skjutlag 9	Tavla 27	Linn Larsson	
----------------------	--------------------	---------------------	--

10m	Gullabo SF	Dam
-----	------------	-----

15.03.2013	SM	Jönköpings SG
------------	----	---------------

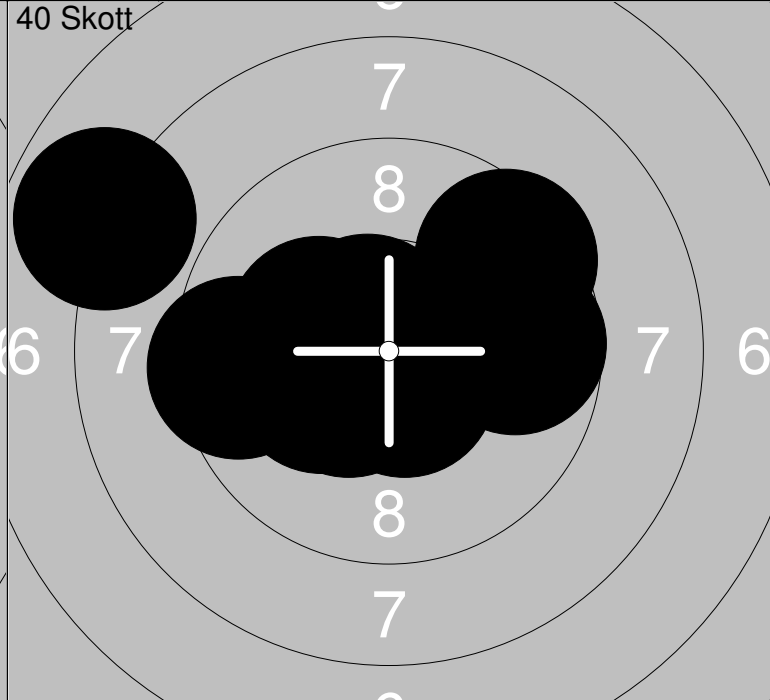
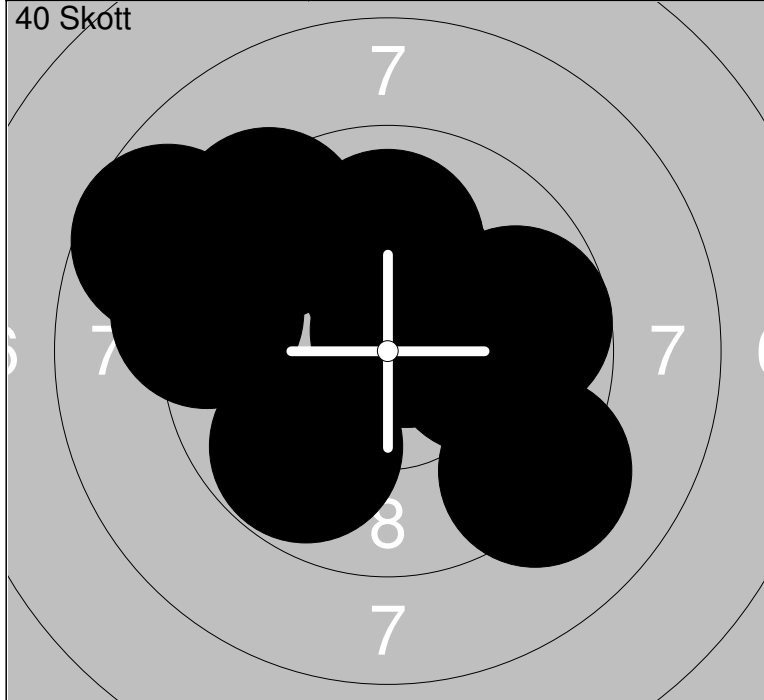

1: 10.0 ↑	6: 9.7 →	Serie	96.9
2: 9.3 ↗	7: *10.2 ↑		
3: 9.2 ←	8: 8.7 ↖	Total	96.9
4: 10.1 →	9: *10.7 ↗		
5: 9.2 ↘	10: 9.8 ↙		

11: 9.5 ←	16: *10.6 ↖	Serie	98.4
12: 9.8 →	17: 9.5 ↗		
13: *10.6 ↘	18: *10.2 ↖	Total	195.3
14: *10.4 ↙	19: *10.2 ↖		
15: 9.7 →	20: 7.9 ←		

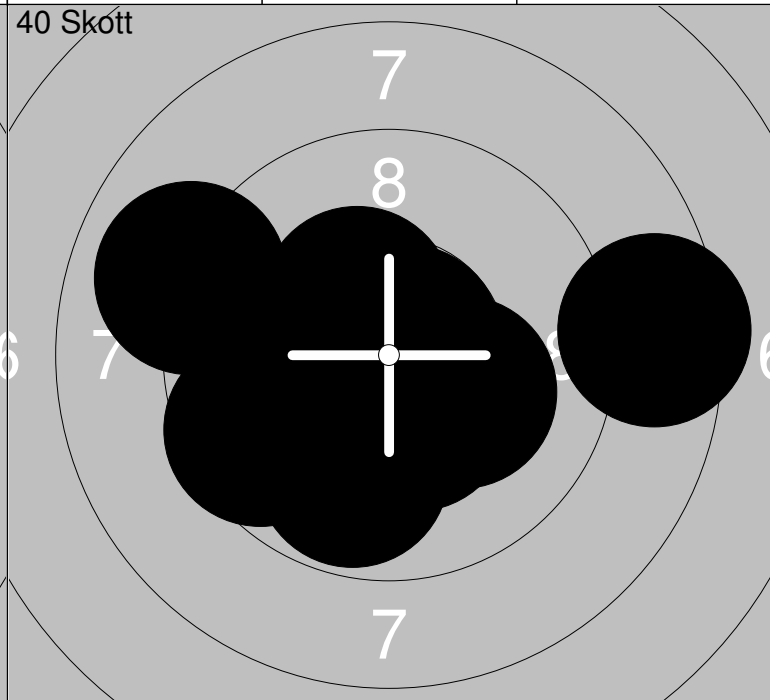
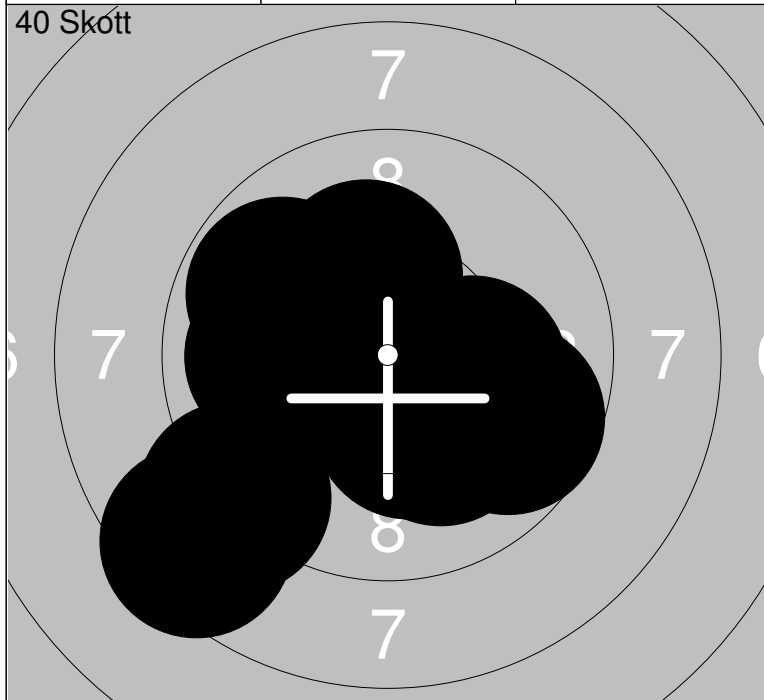

21: *10.3 ↘	26: *10.2 ↑	Serie	98.1
22: 10.1 →	27: 9.8 ↖		
23: 10.0 ←	28: *10.4 ↘	Total	293.4
24: 8.5 ↙	29: 9.7 →		
25: 10.1 ↘	30: 9.0 ↙		

31: 8.5 →	36: 9.6 ↖	Serie	99.1
32: 9.8 ↘	37: *10.7 ↗		
33: *10.3 ↘	38: *10.2 ↘	Total	392.5
34: *10.4 ↘	39: *10.2 ↖		
35: 9.0 ←	40: *10.4 ↗		

Skjutlag	Tavla	Anna Östman	
9	28		

10m	Ramselefors SF	Dam	
-----	----------------	-----	--

15.03.2013	SM	Jönköpings SG	
------------	----	---------------	--

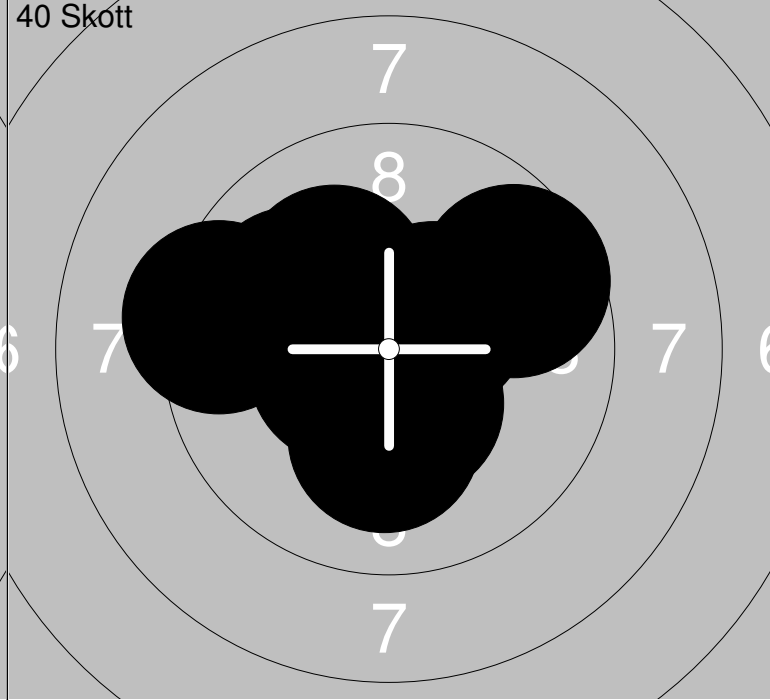
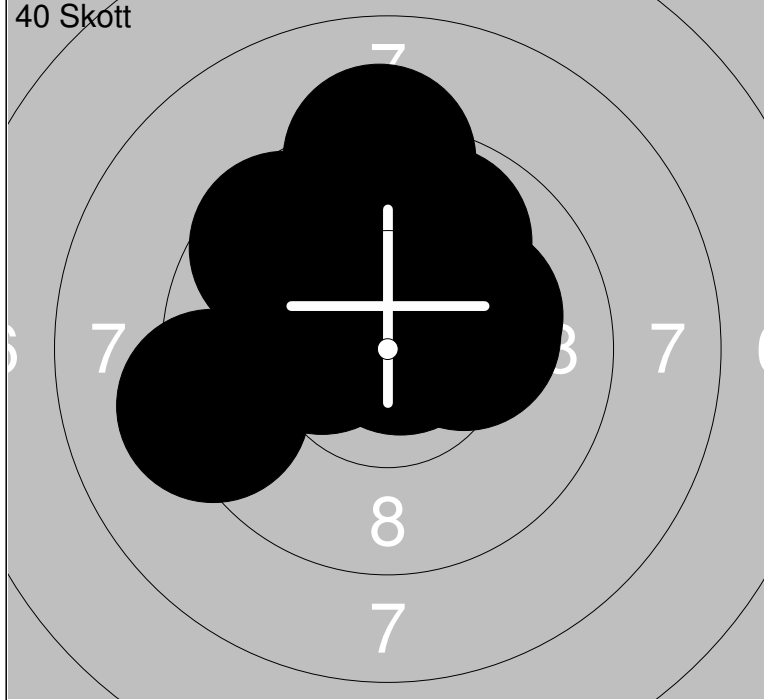

1: 9.9 ↗	6: 9.2 ←	Serie	99.5
2: *10.2 ↗	7: 9.2 ↑		
3: *10.2 →	8: *10.2 →	Total	99.5
4: *10.8 ↗	9: 9.9 ↗		
5: *10.3 ←	10: 9.6 ↖		

11: *10.7 ←	16: *10.5 ←	Serie	101.8
12: 10.1 ↖	17: 9.6 ↗		
13: 10.0 ←	18: 10.1 ↓	Total	201.3
14: *10.4 ↗	19: *10.7 →		
15: *10.4 ↓	20: 9.3 ←		

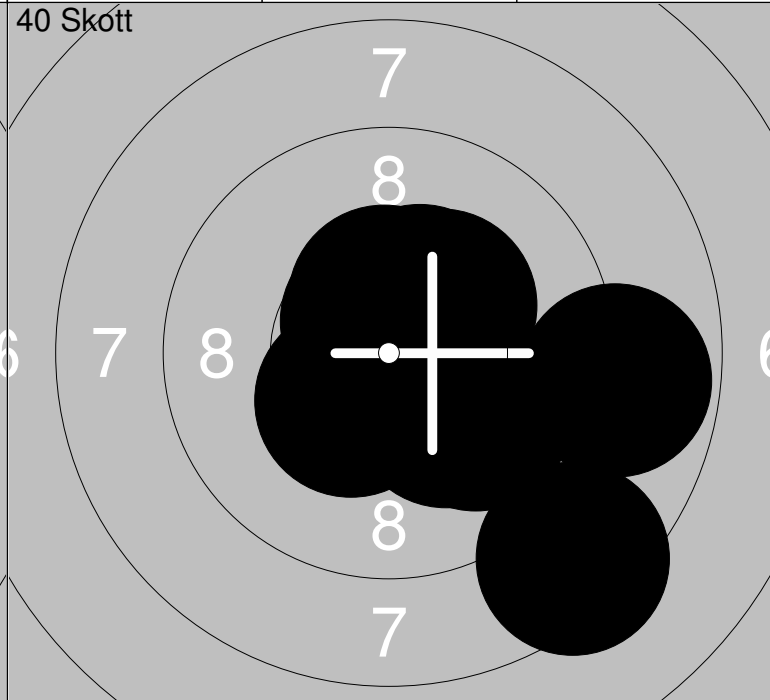
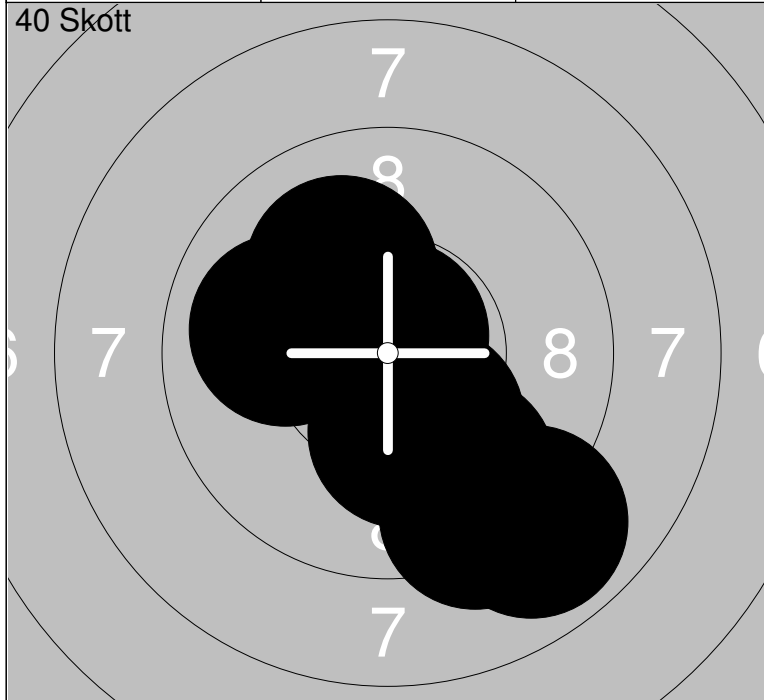

21: *10.5 ↗	26: 10.0 ←	Serie	100.5
22: 9.7 ↓	27: *10.2 ↓		
23: *10.2 ↓	28: *10.8 ↑	Total	301.8
24: 8.9 ↓	29: *10.8 ↖		
25: 9.3 ↓	30: 10.1 ↗		

31: *10.2 ↓	36: *10.6 ↗	Serie	100.5
32: 8.4 ↓	37: *10.9 ↑		
33: 10.0 ↓	38: 8.8 →	Total	402.3
34: *10.4 ↓	39: *10.5 ↑		
35: *10.4 ↗	40: *10.3 ↗		

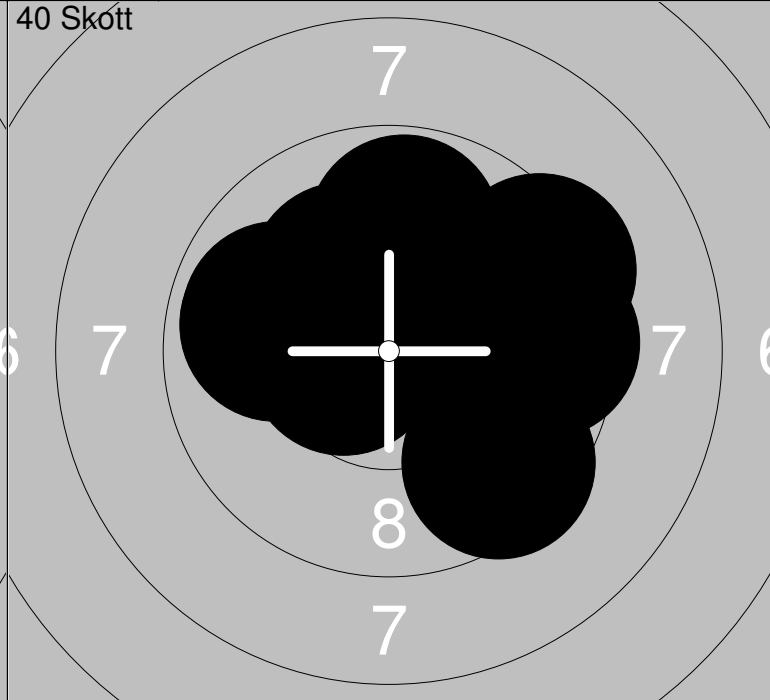
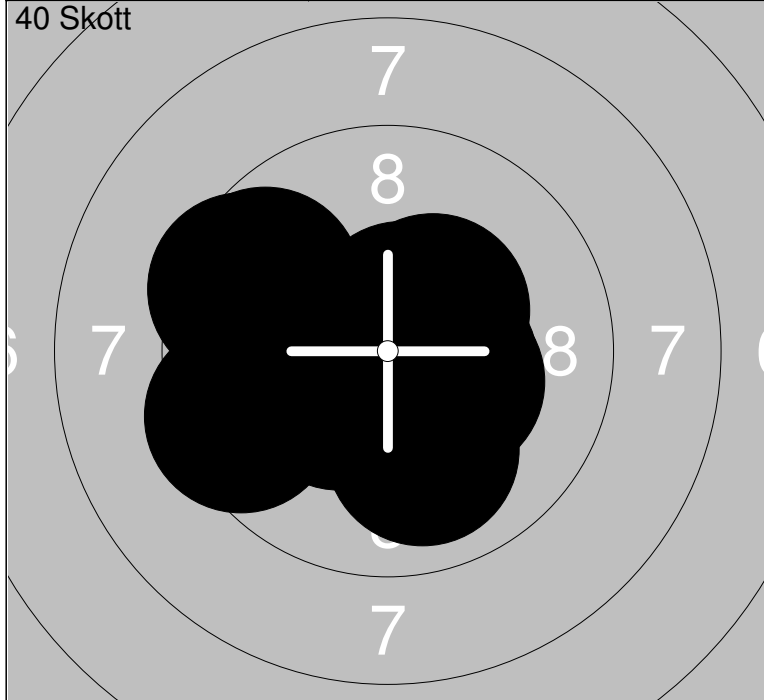

1: *10.4 ↙	6: *10.4 ↗	Serie	101.3
2: *10.6 ↑	7: 10.0 ↓		
3: *10.5 ↙	8: 9.7 ↖	Total	101.3
4: 9.5 ↖	9: 9.5 ←		
5: *10.3 ↘	10: *10.4 →		

11: *10.5 ←	16: 9.4 ↗	Serie	99.9
12: 9.5 →	17: *10.7 ↗		
13: 9.5 ↘	18: 9.9 ←	Total	201.2
14: *10.2 ↗	19: 9.8 ↑		
15: 9.9 ←	20: *10.5 ↑		

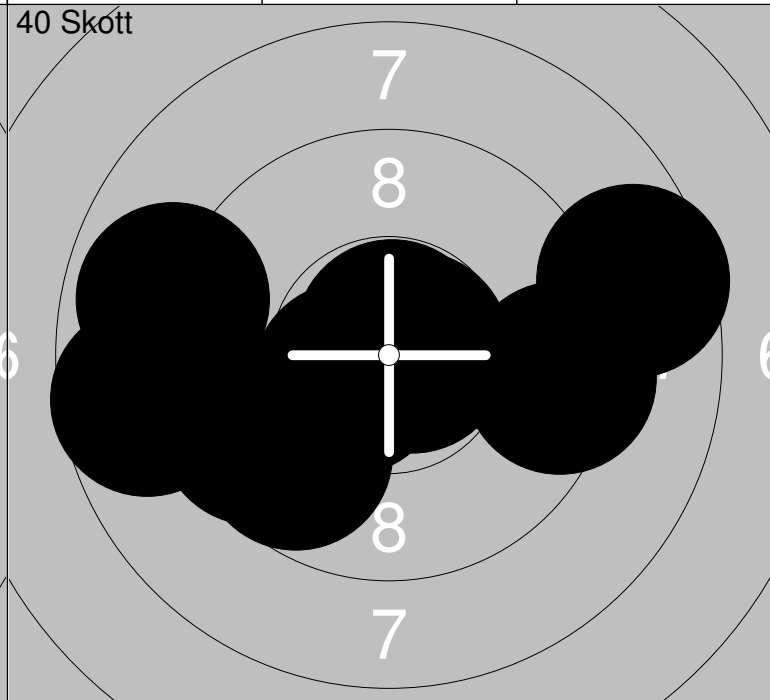
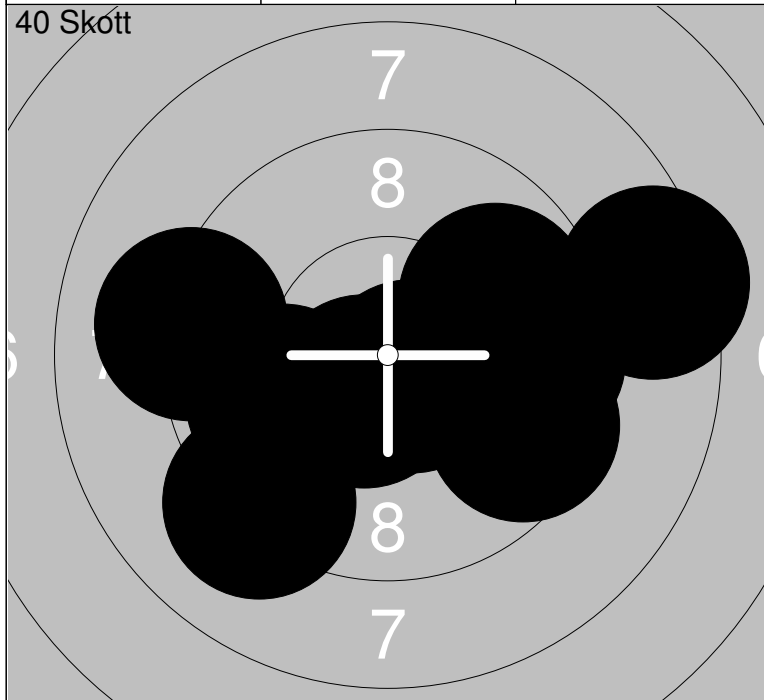

21: *10.3 →	26: 9.6 →	Serie	97.0
22: 9.8 ↗	27: *10.7 ↘		
23: 9.5 ↘	28: *10.6 ↙	Total	298.2
24: 9.9 ←	29: 9.1 ←		
25: 8.4 →	30: 9.1 ↙		

31: 8.9 ←	36: *10.8 ↑	Serie	97.4
32: *10.7 →	37: 8.6 →		
33: 9.5 ↙	38: 9.3 →	Total	395.6
34: 8.7 ←	39: *10.7 →		
35: 9.7 ↙	40: *10.5 ←		