

Skjutlag	Tavla	Johanna Nyman	
7	31		

10m	Ängelholms SF	Dam	
-----	---------------	-----	--

15.03.2013	SM	Jönköpings SG	
------------	----	---------------	--

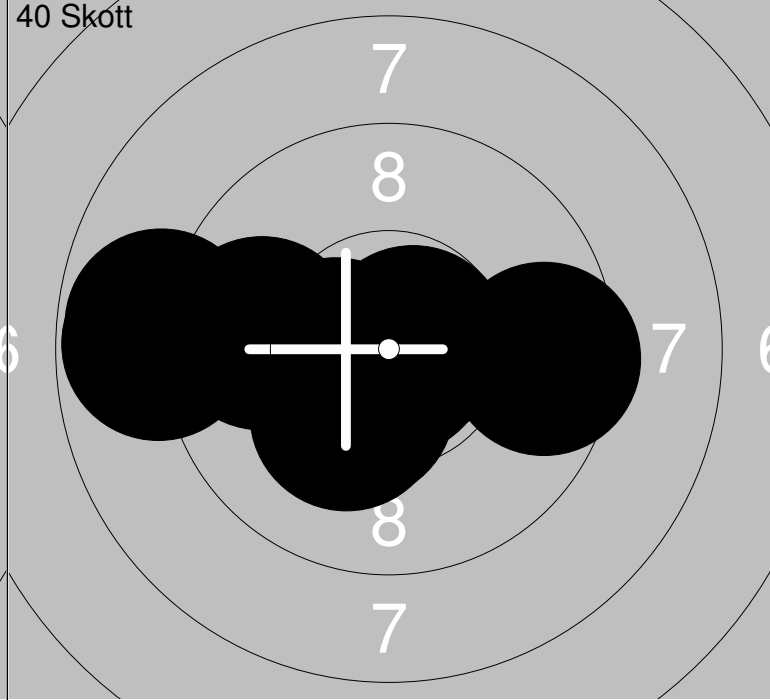
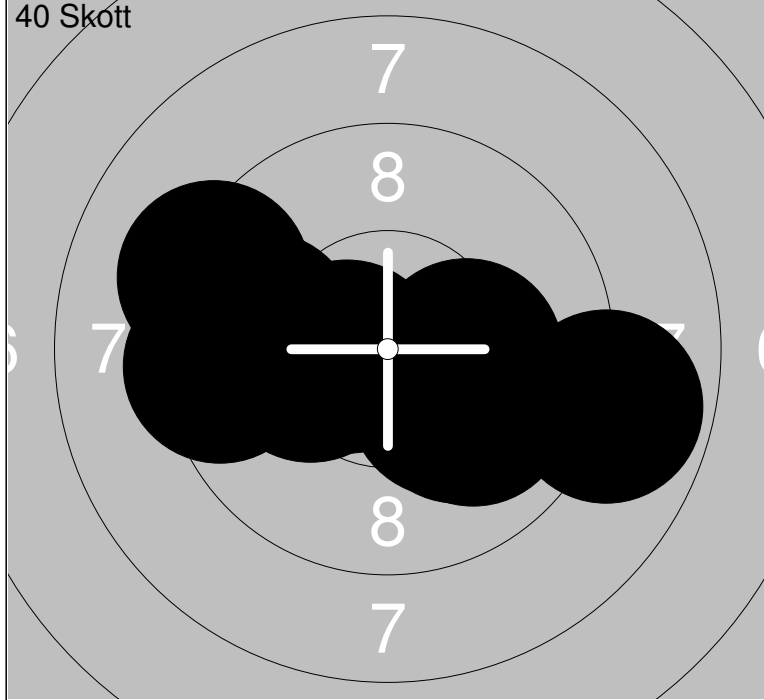

1: *10.2←	6: 8.8 →	Serie	98.5
2: *10.2→	7: 9.8 ←		
3: *10.6←	8: 10.0 ↓	Total	98.5
4: *10.2 ↓	9: 9.4 ←		
5: 10.1 ↓	10: 9.2 ←		

11: *10.8 ↓	16: *10.4 ↓	Serie	100.2
12: 8.8 ←	17: *10.2 ↓		
13: 9.8 ←	18: *10.7→	Total	198.7
14: 8.8 ←	19: *10.7←		
15: *10.5←	20: 9.5 →		

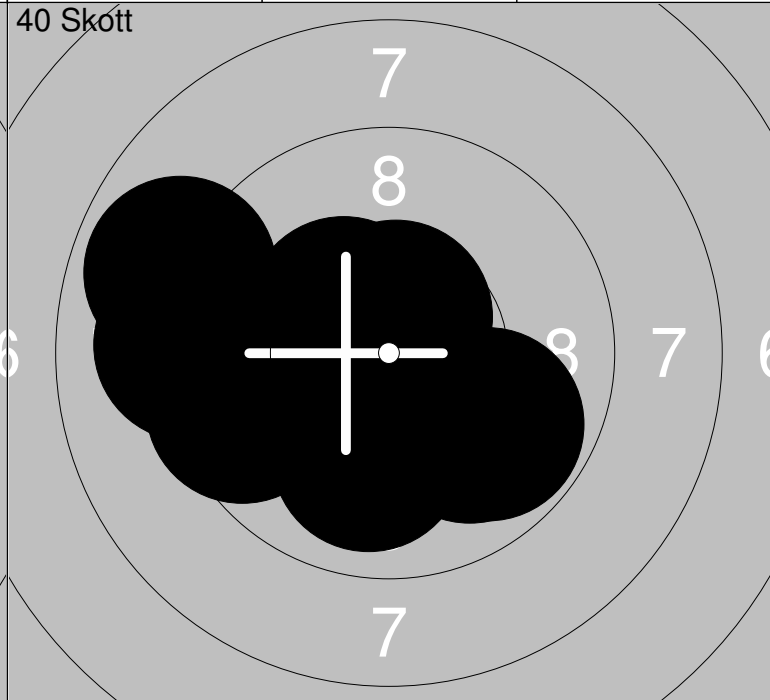
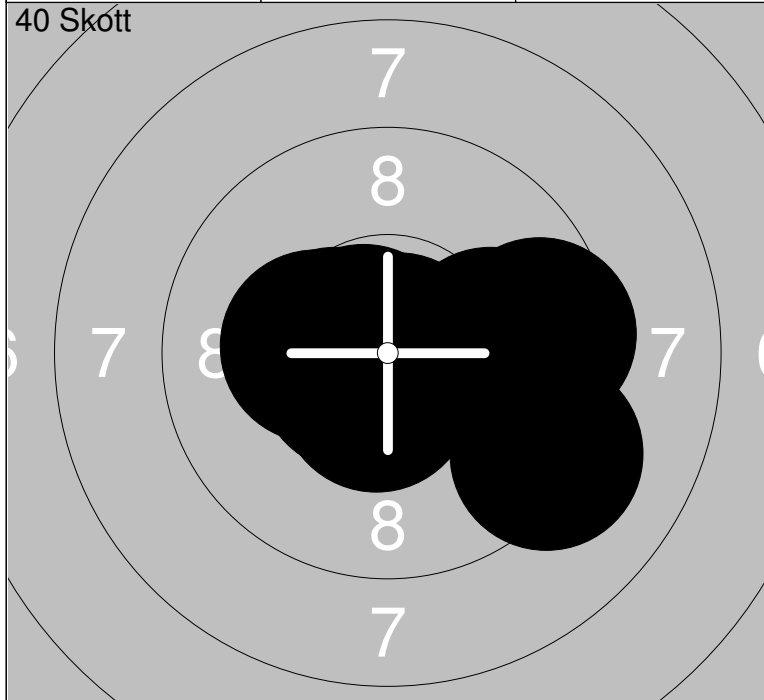

21: 9.5 →	26: 9.2 ↓	Serie	103.0
22: *10.5←	27: *10.6←		
23: *10.7←	28: *10.5 ↓	Total	301.7
24: 10.0 →	29: *10.3←		
25: *10.8→	30: *10.9→		

31: 8.9 ←	36: *10.6 ↑	Serie	99.5
32: *10.6 ↓	37: 9.5 ←		
33: 9.9 ↓	38: 10.0 ↓	Total	401.2
34: 9.8 ↓	39: *10.7←		
35: *10.4 ↗	40: 9.1 ←		

Skjutlag	Tavla	Matilda Nyrell	
7	32		

10m	Sjuhäradsbygdens SpSK	Dam	
-----	-----------------------	-----	--

15.03.2013	SM	Jönköpings SG	
------------	----	---------------	--

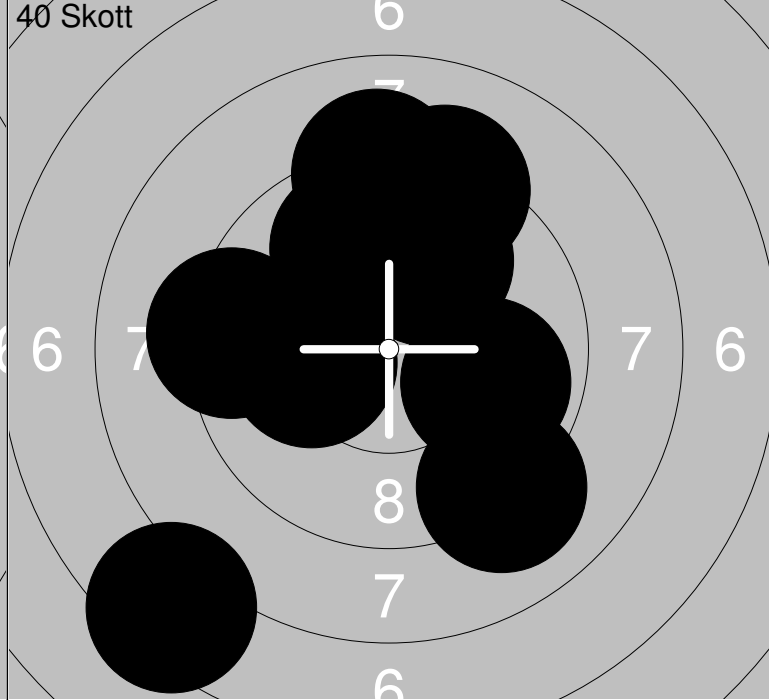
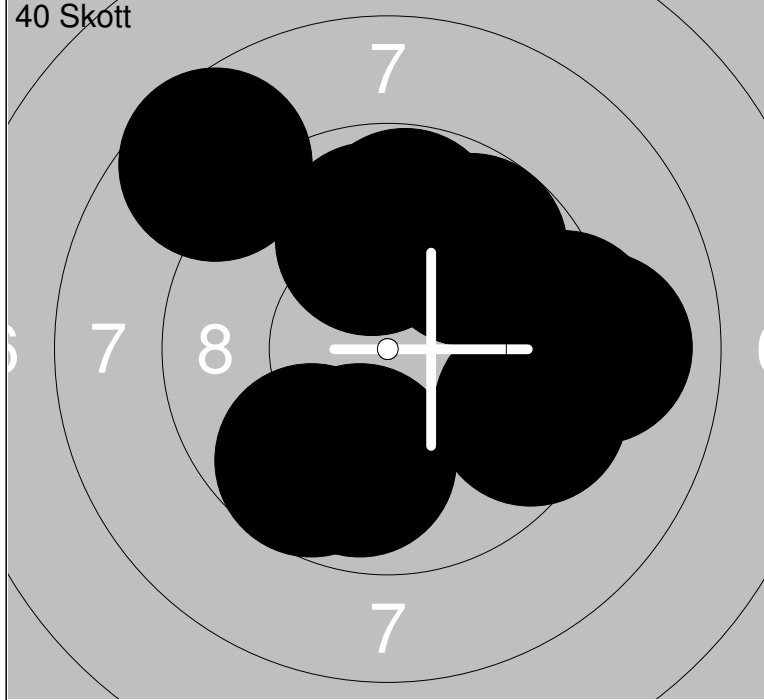

1: 9.8 ↑	6: 9.9 ↓	Serie	94.9	11: 9.2 ↑	16: 9.9 →	Serie	93.1
2: 9.9 ↑	7: 9.7 ↗			12: 9.9 ↑	17: 10.1 ←		
3: 9.5 →	8: 9.0 →	Total	94.9	13: 9.1 ↘	18: 9.3 ↑	Total	188.0
4: 9.7 ↙	9: 9.3 →			14: 9.8 ↑	19: 9.3 ←		
5: 9.5 ↘	10: 8.6 ↖			15: 9.1 ↑	20: 7.4 ↙		

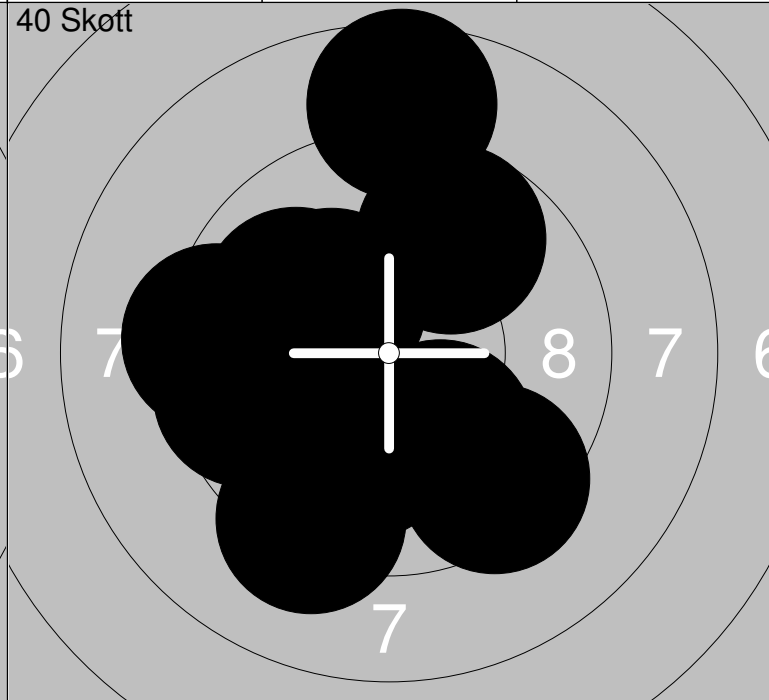
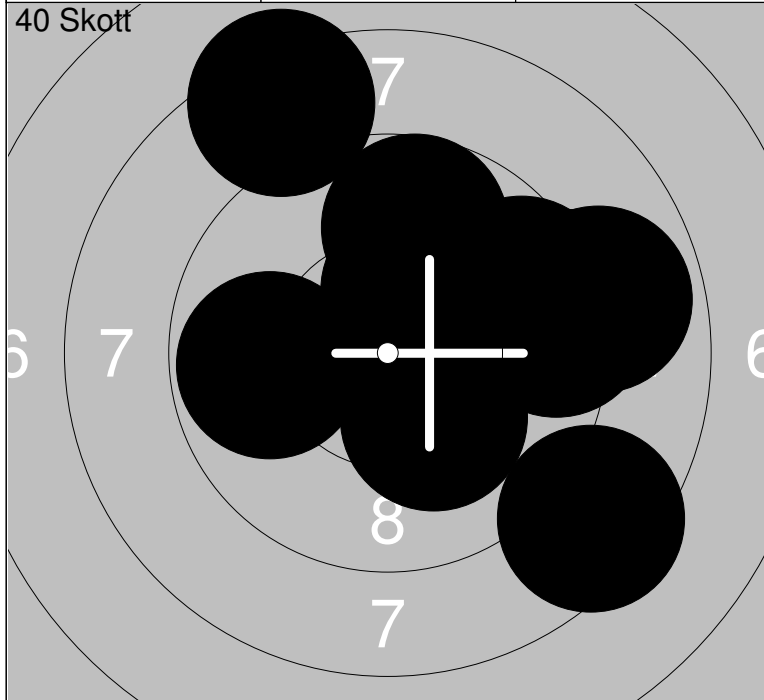

21: 8.9 →	26: 9.8 ←	Serie	93.5	31: 9.2 ↓	36: 9.3 ←	Serie	96.0
22: *10.3 ↑	27: 9.3 →			32: 9.6 ←	37: *10.2 ↖		
23: 9.1 →	28: 8.4 ↘	Total	281.5	33: 9.4 ↘	38: 9.9 ↖	Total	377.5
24: 9.7 ↑	29: *10.2 ↘			34: 10.1 ↓	39: 8.6 ↑		
25: 9.5 ↗	30: 8.3 ↖			35: 10.0 ↘	40: 9.7 ↑		

Skjutlag 7	Tavla 33	Linda Andersson
----------------------	--------------------	------------------------

10m	Morups SF	Dam
-----	-----------	-----

15.03.2013	SM	Jönköpings SG
------------	----	---------------

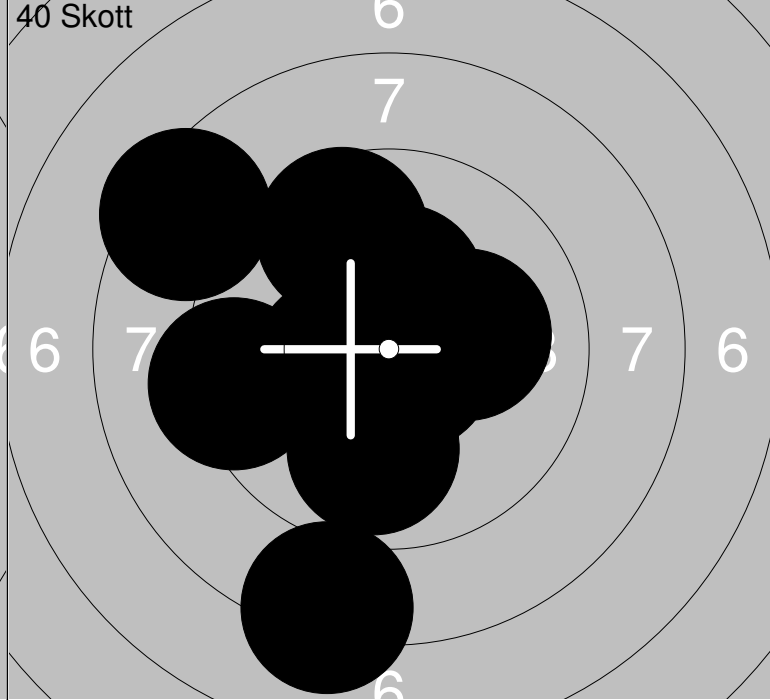
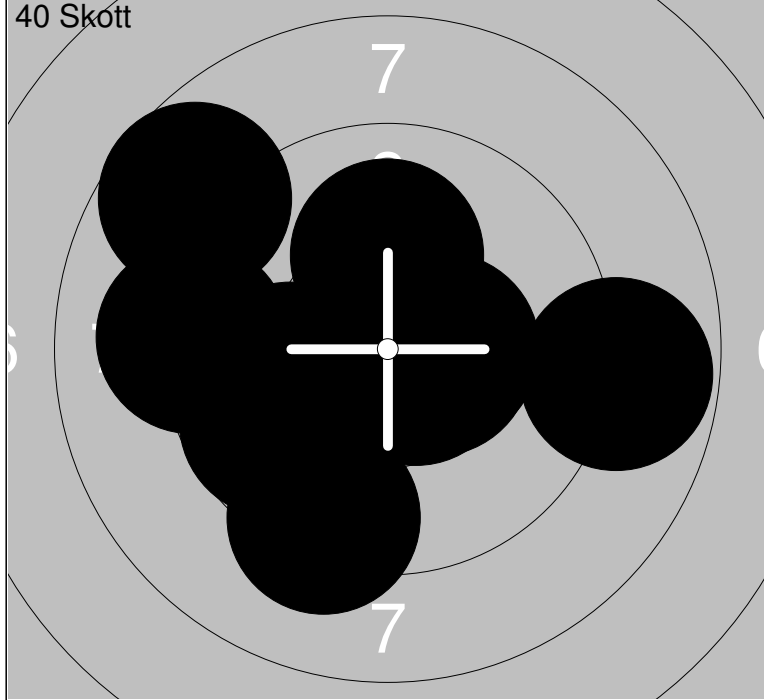

1: 10.0 ←	6: 8.7 ↖	Serie	97.2
2: 8.8 →	7: 9.3 ↓		
3: 9.1 ←	8: *10.6 ↘	Total	97.2
4: 10.1 ↑	9: *10.4 →		
5: *10.5 →	10: 9.7 ↙		

11: 9.6 ↑	16: *10.3 ↑	Serie	97.1
12: *10.7 ↘	17: 9.9 ↓		
13: 8.2 ↓	18: *10.2 ↓	Total	194.3
14: *10.4 ←	19: 8.4 ↖		
15: 9.3 ←	20: 10.1 →		

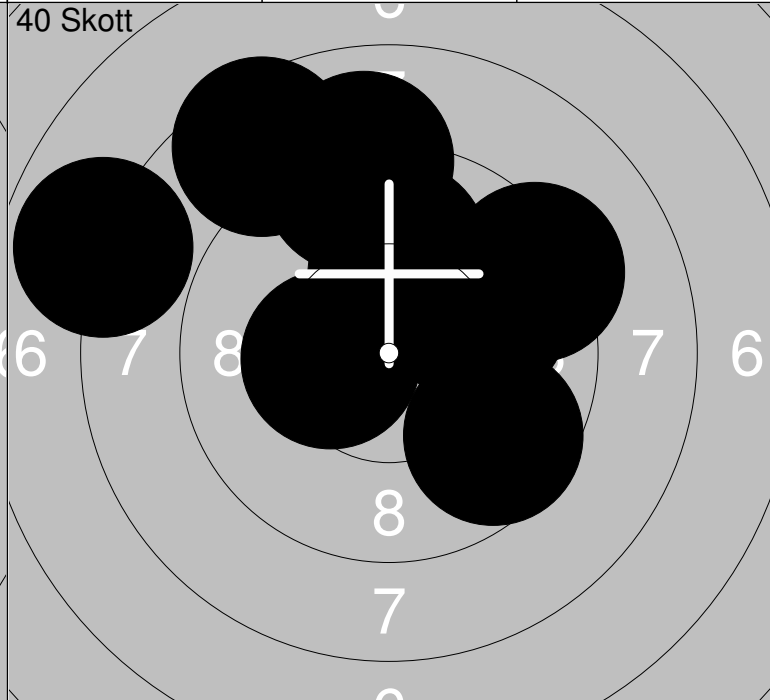
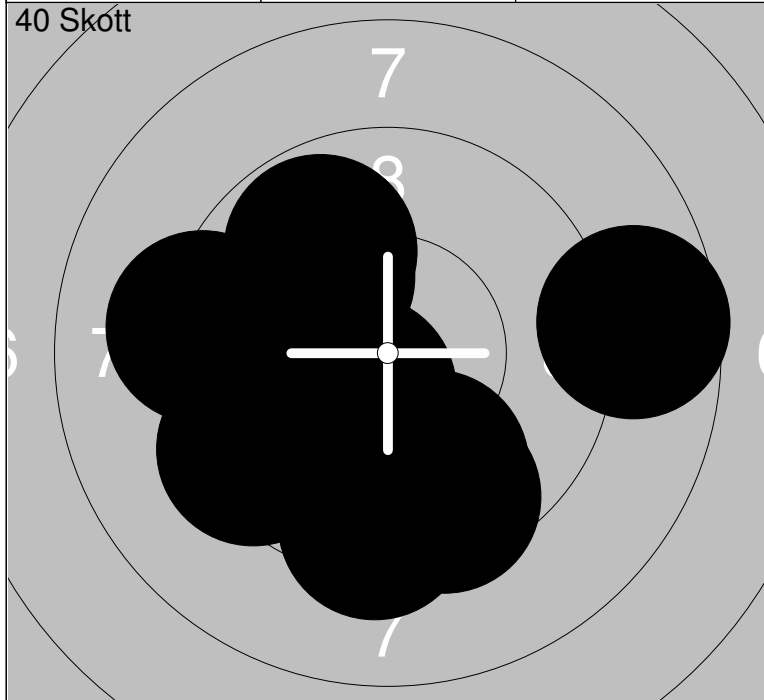

21: 9.4 ↙	26: 9.2 ←	Serie	96.0
22: 9.8 ↓	27: 9.8 ←		
23: *10.5 ↘	28: 9.8 ↗	Total	290.3
24: 9.5 ↓	29: 8.6 →		
25: 9.4 ↓	30: 10.0 ↗		

31: *10.4 ←	36: *10.2 ↑	Serie	94.0
32: 10.0 →	37: 9.9 ↑		
33: 9.6 ↘	38: 9.0 ↑	Total	384.3
34: 9.2 ↑	39: 8.5 ↖		
35: 7.9 ←	40: 9.3 →		

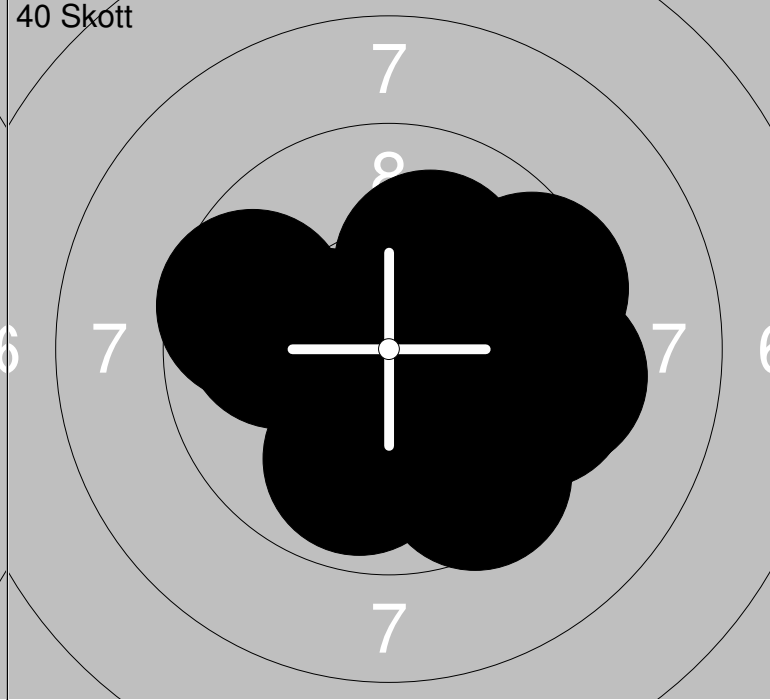
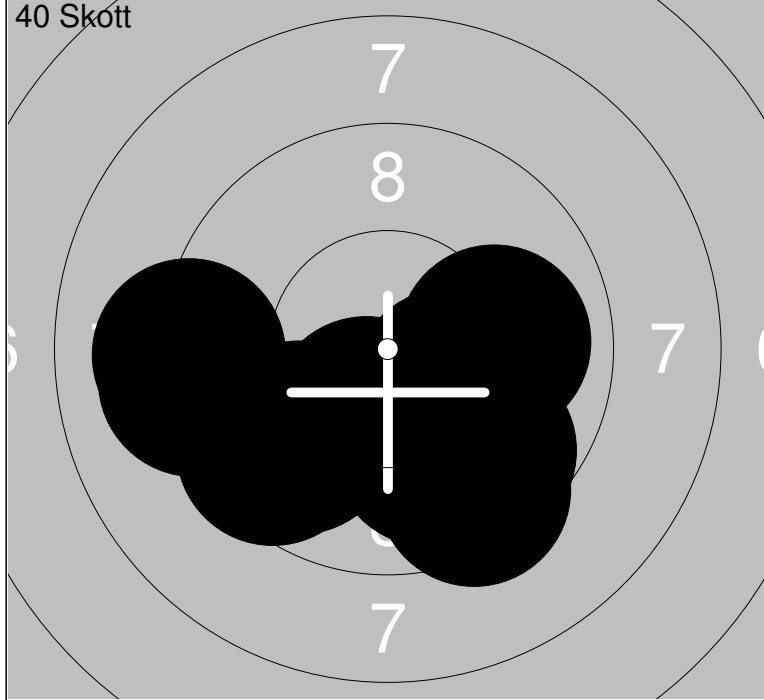

1: *10.3 ↘	6: 10.0 →	Serie 97.1
2: 9.1 ←	7: 9.8 ↙	
3: 9.4 ↘	8: 9.5 ↙	Total 97.1
4: 9.1 ←	9: 9.7 ↘	
5: 9.9 ↘	10: *10.3 ↘	

11: 10.0 ↘	16: 9.5 ↘	Serie 97.7
12: *10.3 ←	17: 9.9 ←	
13: 9.6 ←	18: 9.4 →	Total 194.8
14: 9.5 →	19: 9.5 →	
15: 10.1 ↗	20: 9.9 ↘	

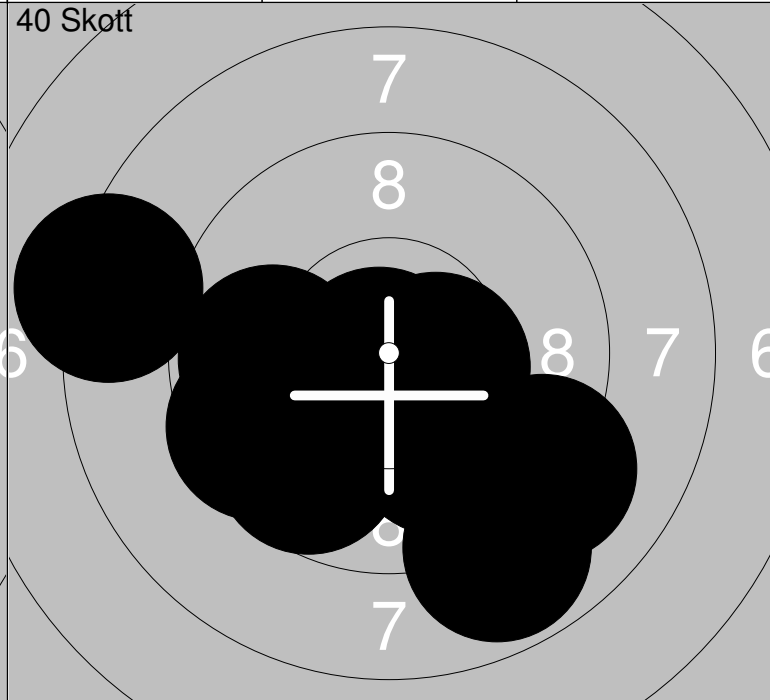

21: 9.0 →	26: 9.7 ←	Serie 98.9
22: *10.9 ↘	27: 8.7 ←	
23: *10.3 →	28: *10.4 ↙	Total 293.7
24: 10.1 ↘	29: 9.5 ↙	
25: *10.7 ↘	30: 9.6 ←	

31: *10.5 →	36: *10.8 ↙	Serie 96.4
32: 9.7 ↘	37: 8.2 ←	
33: 10.0 ↘	38: 9.5 ↙	Total 390.1
34: 9.1 ↘	39: 9.8 ←	
35: 10.0 ↘	40: 8.8 ↘	

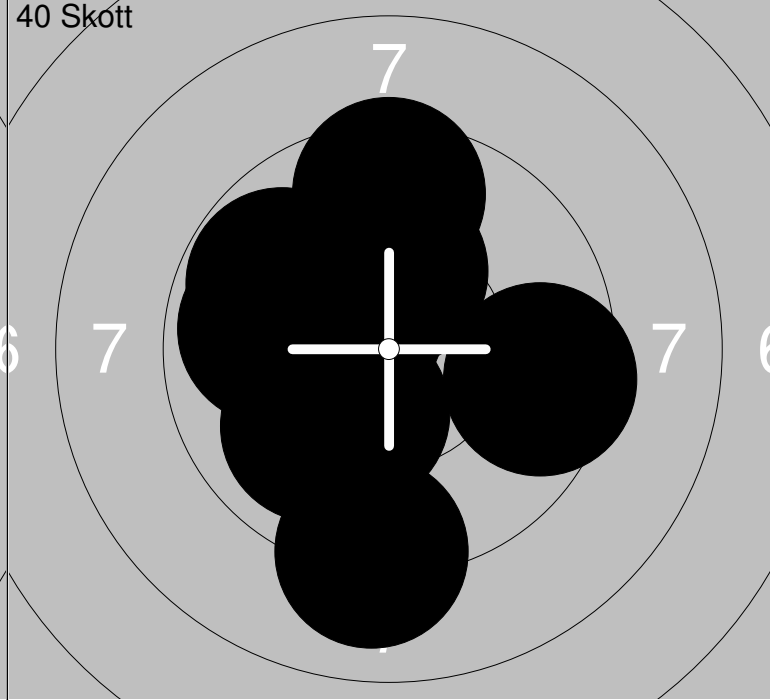
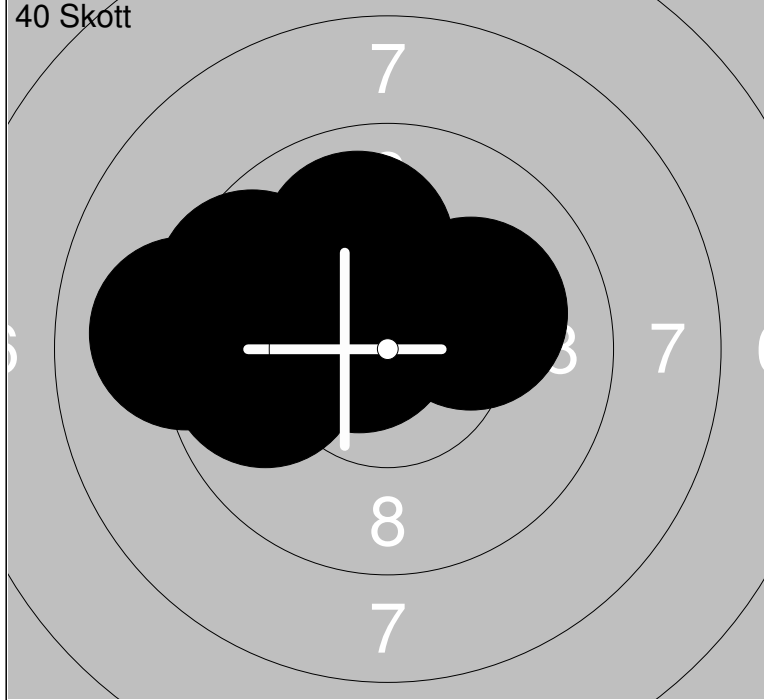

1: *10.7 ↗	6: *10.2 ←	Serie	99.7
2: 10.0 ↑	7: 10.1 →		
3: 9.6 ↖	8: 9.1 ←	Total	99.7
4: *10.7 ↖	9: 9.8 ←		
5: 9.7 ←	10: 9.8 ←		

11: *10.5 ↖	16: 9.5 ↑	Serie	99.0
12: 9.8 ↖	17: 10.0 ↘		
13: *10.2 ↑	18: *10.2 ↑	Total	198.7
14: 9.9 ←	19: 9.5 →		
15: *10.3 ↘	20: 9.1 ↓		

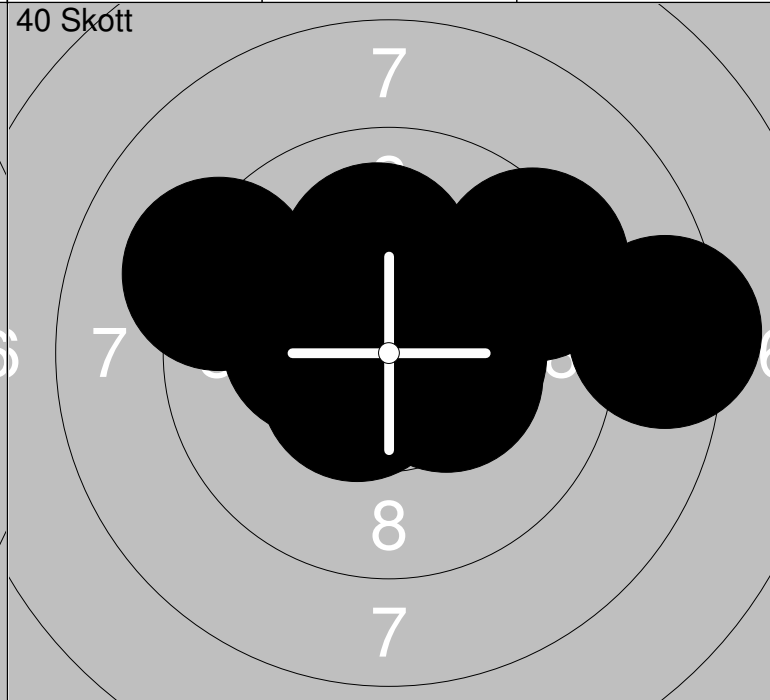
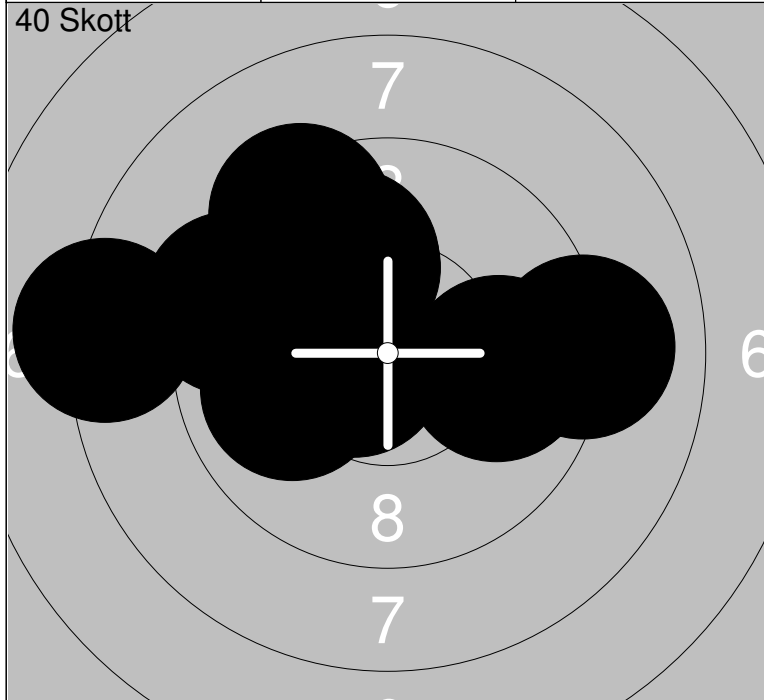

21: 9.4 ↗	26: 10.0 ↑	Serie	96.4
22: 9.9 →	27: 9.0 →		
23: 8.2 ←	28: 10.0 ↑	Total	295.1
24: 10.0 ←	29: 9.9 →		
25: 9.4 ←	30: *10.6 ←		

31: *10.4 →	36: *10.5 ↑	Serie	99.8
32: 10.1 ↑	37: *10.3 ←		
33: 9.4 ↗	38: *10.5 ↘	Total	394.9
34: 9.2 ↖	39: *10.6 ↗		
35: *10.4 →	40: 8.4 →		