

Skjutlag

Tavla

6

31

Andreas Karlsson

10m

KA 3 Skytteförening

Herr

15.03.2013

SM

Jönköpings SG

60 Skott

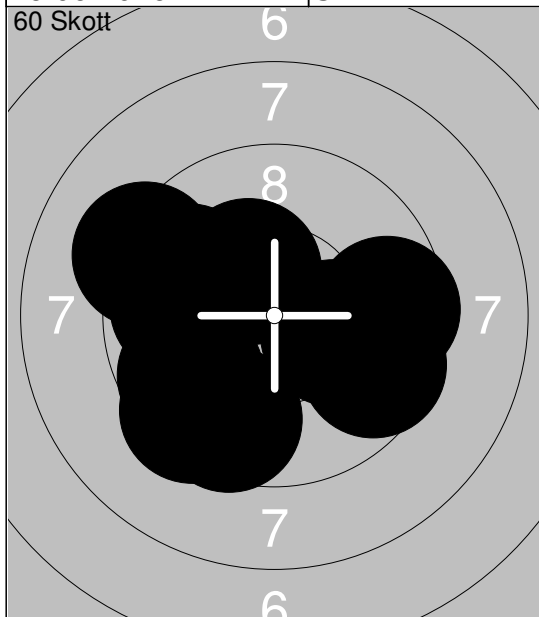

1: 9.8 ←
 2: *10.3 ↗
 3: 9.7 ↙
 4: 9.8 ↖
 5: 9.6 →
 6: 9.4 ↙
 7: 9.6 →
 8: 9.2 ↖
 9: 9.6 ↓
 10: *10.2 →

Serie 97.2

Total 97.2

60 Skott

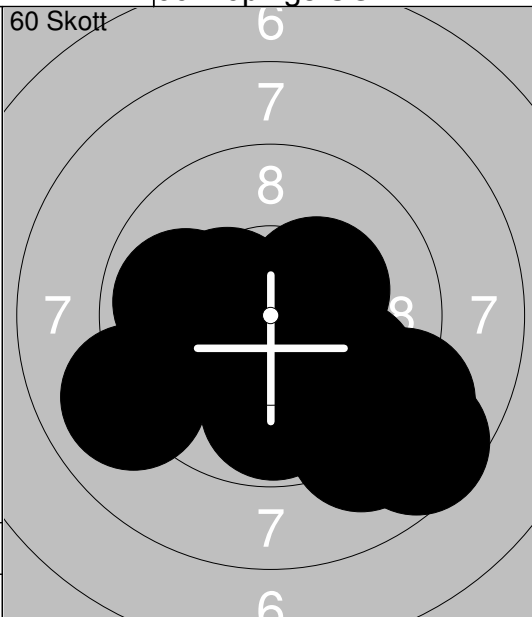

11: *10.3 ↗
 12: 8.6 ↘
 13: 9.8 ↘
 14: 9.8 ↓
 15: 9.1 ↘
 16: 9.9 ←
 17: *10.4 ↖
 18: 9.0 →
 19: 9.0 ←
 20: *10.2 ↖

Serie 96.1

Total 193.3

60 Skott

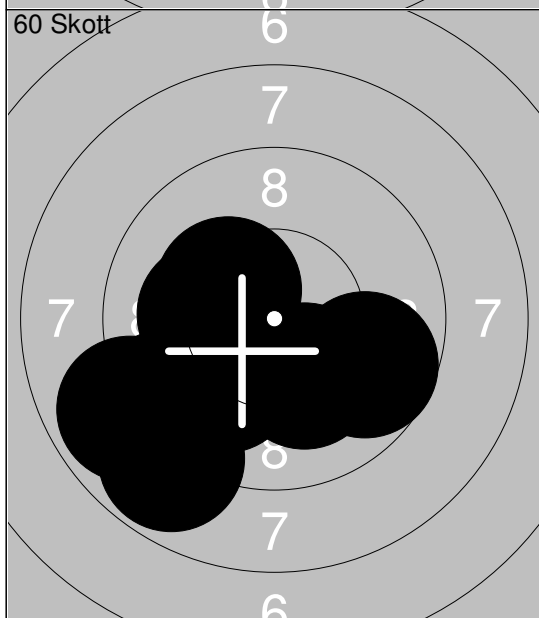

21: 10.0 ↙
 22: 8.8 ↙
 23: *10.4 ↖
 24: 8.9 ↙
 25: 9.7 →
 26: *10.2 ↘
 27: 10.0 ↙
 28: 9.3 ↙
 29: *10.2 ↖
 30: *10.3 ↖

Serie 97.8

Total 291.1

60 Skott

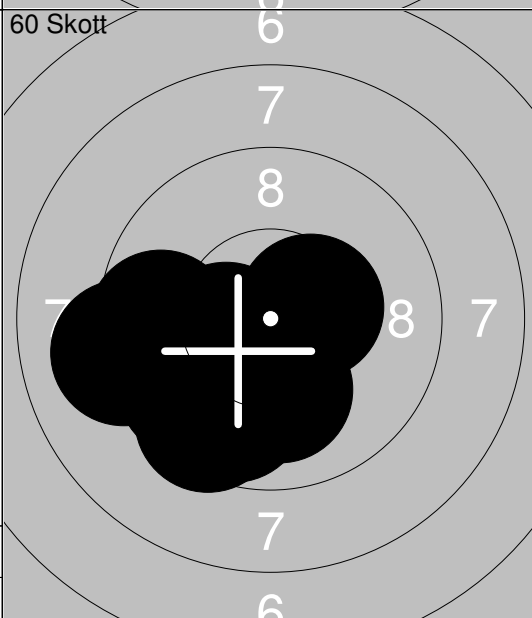

31: 10.1 ↓
 32: 9.8 ↙
 33: 9.1 ←
 34: 9.6 ←
 35: 9.7 ↙
 36: *10.4 ↖
 37: 9.5 ↙
 38: 9.8 ←
 39: *10.4 →
 40: *10.2 ↓

Serie 98.6

Total 389.7

60 Skott

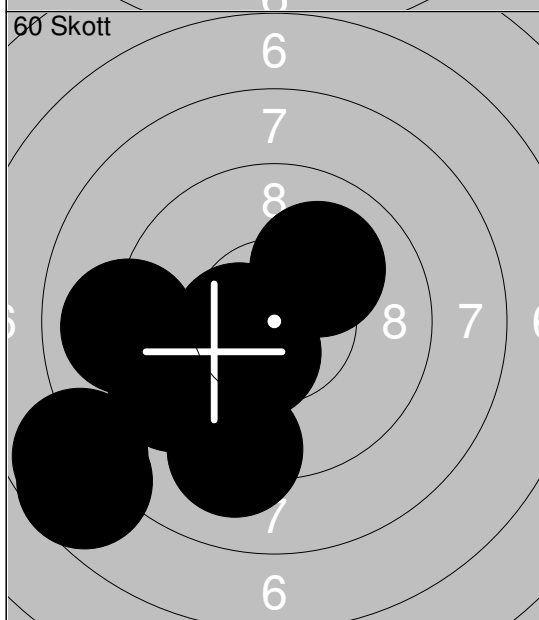

41: 7.8 ↙
 42: *10.5 ↘
 43: 10.1 ↗
 44: 9.2 ↓
 45: *10.4 ↘
 46: *10.2 ↘
 47: 9.4 ↙
 48: 9.0 ←
 49: 7.7 ↙
 50: *10.5 ↖

Serie 94.8

Total 484.5

60 Skott

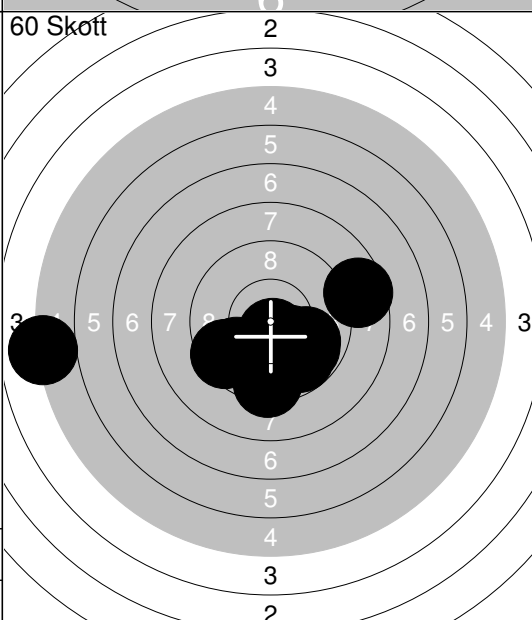

51: 5.0 ←
 52: 8.6 →
 53: 9.4 ↓
 54: 9.7 ↘
 55: 9.9 →
 56: *10.3 ↘
 57: 9.8 ↙
 58: 9.5 ↙
 59: 9.8 ↘
 60: *10.7 ↓

Serie 92.7

Total 577.2

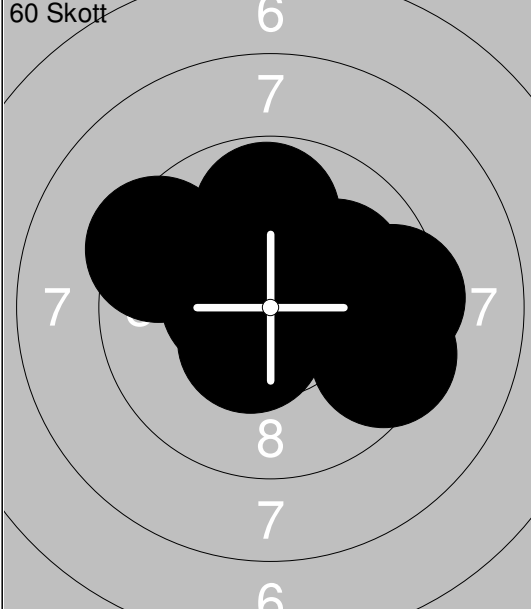
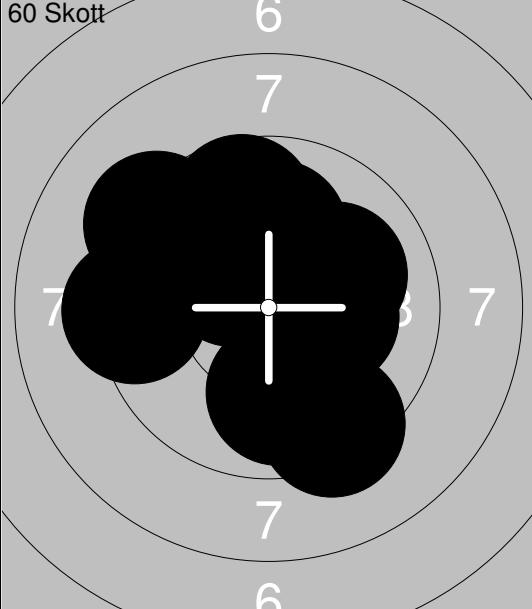
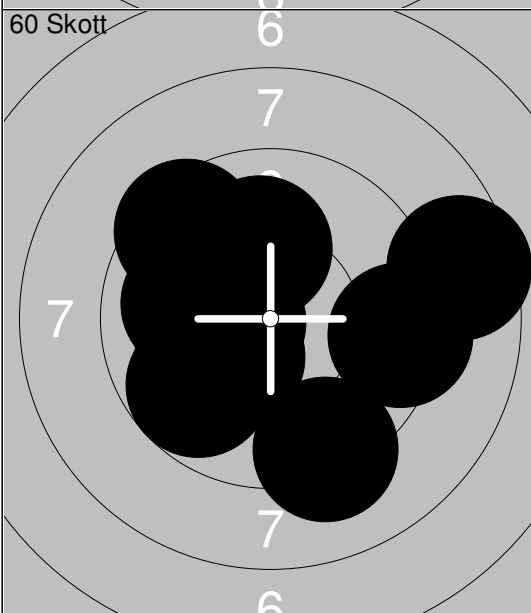
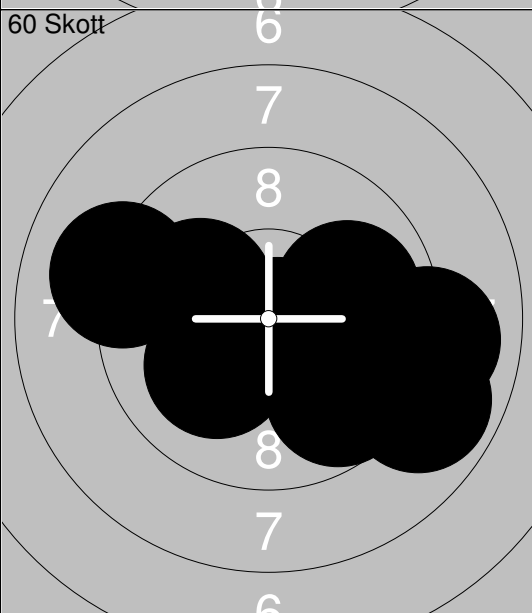
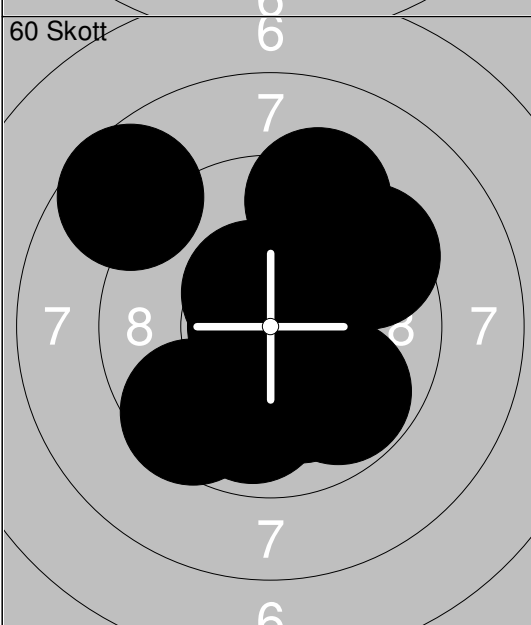
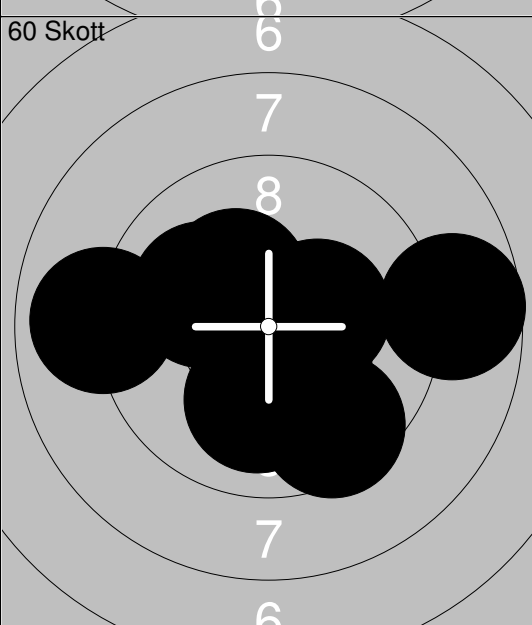
<p>60 Skott</p> 	<p>1: *10.5 ↗</p> <p>2: *10.5 ↘</p> <p>3: 9.5 →</p> <p>4: 9.4 ←</p> <p>5: 9.8 ↑</p> <p>6: *10.5 ←</p> <p>7: 10.1 ↗</p> <p>8: 9.6 →</p> <p>9: *10.9 ↘</p> <p>10: 9.5 ↘</p> <hr/> <p>Serie 100.3</p> <hr/> <p>Total 100.3</p>	<p>60 Skott</p> 	<p>11: 10.1 ↗</p> <p>12: *10.4 ↘</p> <p>13: *10.6 ↘</p> <p>14: 9.7 ↑</p> <p>15: 9.3 ↓</p> <p>16: *10.2 ↘</p> <p>17: 10.0 ↑</p> <p>18: 9.3 ←</p> <p>19: 9.2 ↘</p> <p>20: 9.9 ↓</p> <hr/> <p>Serie 98.7</p> <hr/> <p>Total 199.0</p>
<p>60 Skott</p> 	<p>21: 10.0 ←</p> <p>22: 9.7 ↘</p> <p>23: 10.1 ↑</p> <p>24: 9.3 →</p> <p>25: 8.5 →</p> <p>26: 9.5 ↗</p> <p>27: *10.5 ←</p> <p>28: 9.2 ↓</p> <p>29: 10.1 ←</p> <p>30: *10.3 ↘</p> <hr/> <p>Serie 97.2</p> <hr/> <p>Total 296.2</p>	<p>60 Skott</p> 	<p>31: 10.1 ↘</p> <p>32: *10.4 ←</p> <p>33: 9.1 ←</p> <p>34: *10.8 ↘</p> <p>35: 9.7 ↓</p> <p>36: 10.1 ←</p> <p>37: 9.4 →</p> <p>38: 8.9 ↘</p> <p>39: 9.9 →</p> <p>40: 9.0 →</p> <hr/> <p>Serie 97.4</p> <hr/> <p>Total 393.6</p>
<p>60 Skott</p> 	<p>41: 9.5 ↘</p> <p>42: *10.5 ↘</p> <p>43: 9.3 ↑</p> <p>44: 9.5 ↗</p> <p>45: 10.1 ↓</p> <p>46: 9.8 ↘</p> <p>47: *10.8 ←</p> <p>48: 9.8 ↗</p> <p>49: 9.9 ↓</p> <p>50: 8.6 ↘</p> <hr/> <p>Serie 97.8</p> <hr/> <p>Total 491.4</p>	<p>60 Skott</p> 	<p>51: 10.0 ↓</p> <p>52: 9.5 ↓</p> <p>53: *10.4 ↘</p> <p>54: *10.3 ↗</p> <p>55: *10.3 →</p> <p>56: 10.1 ←</p> <p>57: 8.7 →</p> <p>58: 8.9 ←</p> <p>59: *10.5 ↘</p> <p>60: *10.3 ↘</p> <hr/> <p>Serie 99.0</p> <hr/> <p>Total 590.4</p>

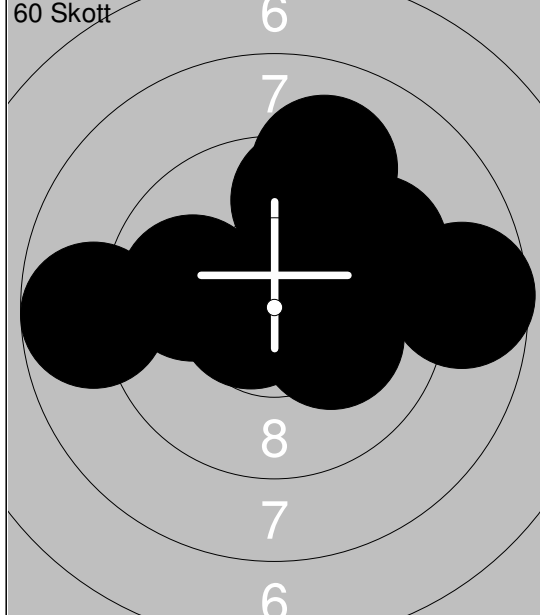

1:	9.9	←
2:	9.9	↗
3:	*10.2	↘
4:	8.7	←
5:	8.7	→
6:	9.1	↗
7:	*10.6	↙
8:	10.1	↗
9:	9.6	↗
10:	9.5	↗
Serie		96.3
Total		96.3

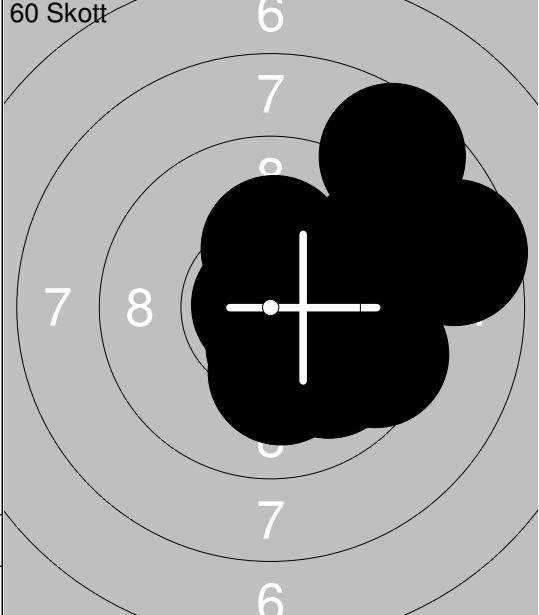

11:	8.6	→
12:	*10.2	↑
13:	10.0	↘
14:	*10.2	↓
15:	9.5	↗
16:	*10.9	↙
17:	8.6	↗
18:	9.5	→
19:	*10.5	↓
20:	*10.2	↘
Serie		98.2
Total		194.5

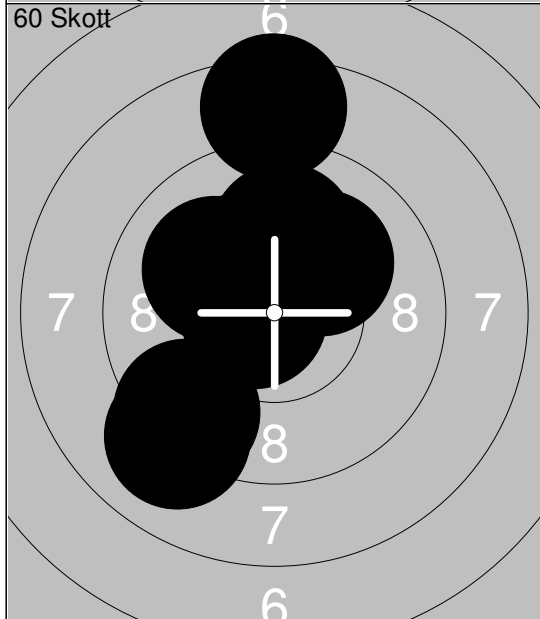

21:	8.4	↑
22:	*10.7	↙
23:	*10.3	↑
24:	10.1	↙
25:	10.1	↗
26:	10.0	↑
27:	9.3	↘
28:	*10.2	↙
29:	9.0	↘
30:	*10.2	↑
Serie		98.3
Total		292.8

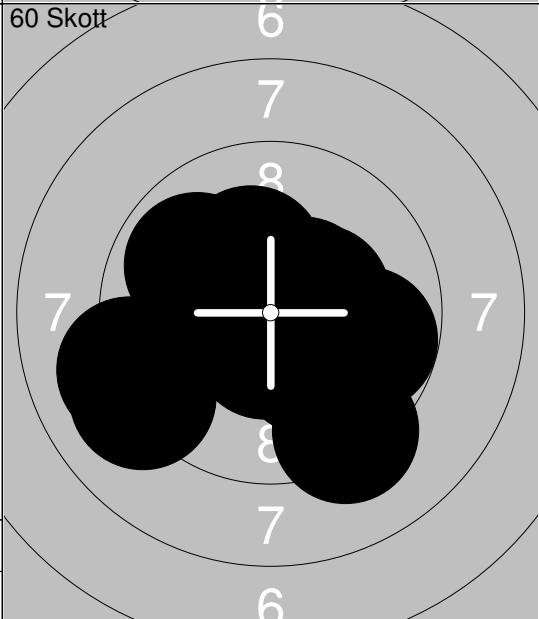

31:	9.9	↙
32:	*10.3	↗
33:	*10.2	↘
34:	*10.5	↓
35:	9.1	←
36:	9.8	→
37:	*10.5	↗
38:	9.1	↙
39:	9.2	↓
40:	*10.4	→
Serie		99.0
Total		391.8

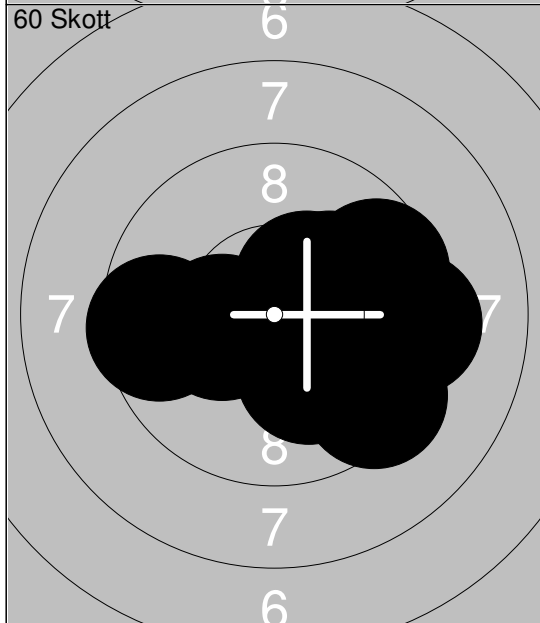

41:	10.0	↘
42:	9.3	→
43:	*10.2	↗
44:	*10.4	↗
45:	*10.3	↙
46:	9.6	→
47:	10.0	→
48:	9.4	↘
49:	10.1	↓
50:	9.5	←
Serie		98.8
Total		490.6

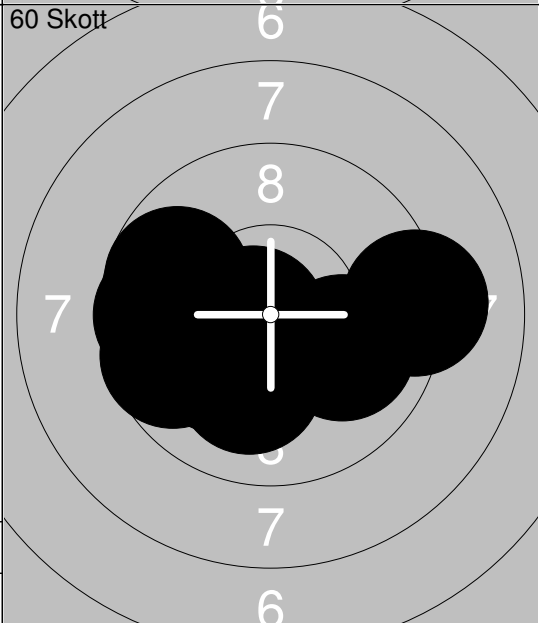

51:	10.0	→
52:	9.7	↙
53:	*10.7	↙
54:	9.7	←
55:	9.7	←
56:	10.1	↙
57:	*10.4	↙
58:	10.1	↙
59:	10.1	↓
60:	9.2	→
Serie		99.7
Total		590.3

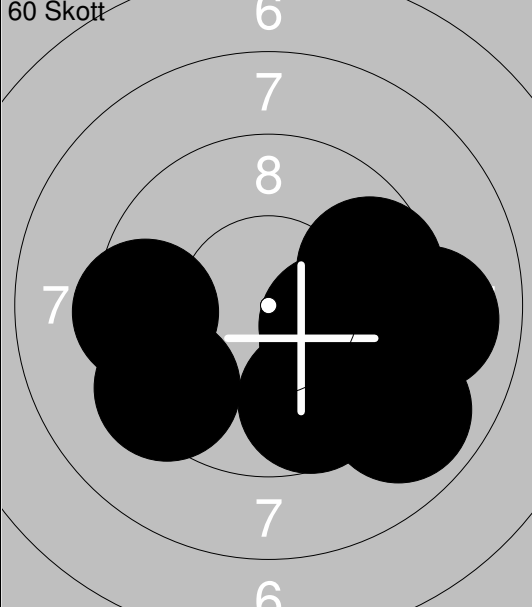
<p>60 Skott</p> 	<p>1: *10.2 ↘ 2: 9.9 ↓ 3: 10.1 → 4: 10.1 ↗ 5: 9.5 ↑ 6: *10.8 ↘ 7: 10.0 ← 8: *10.5 ↘ 9: 9.0 ← 10: *10.2 →</p> <p>Serie 100.3 Total 100.3</p>	<p>60 Skott</p> 	<p>11: 9.7 ↓ 12: 9.4 → 13: 9.0 → 14: 9.6 → 15: 8.9 ↘ 16: 10.0 → 17: 9.4 ↙ 18: 10.1 → 19: 9.4 ← 20: 9.4 →</p> <p>Serie 94.9 Total 195.2</p>
--	--	--	---

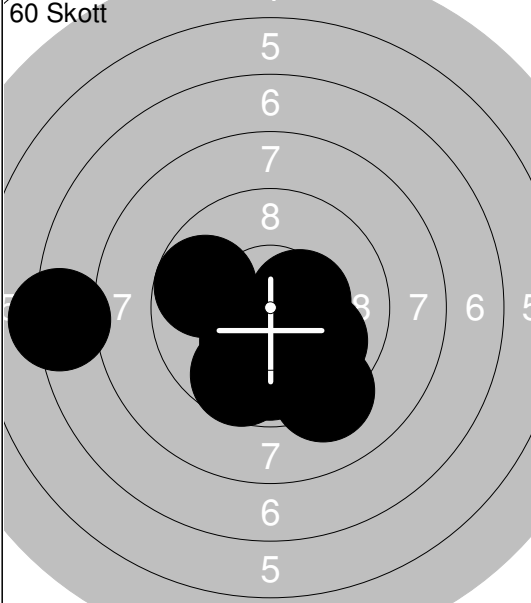
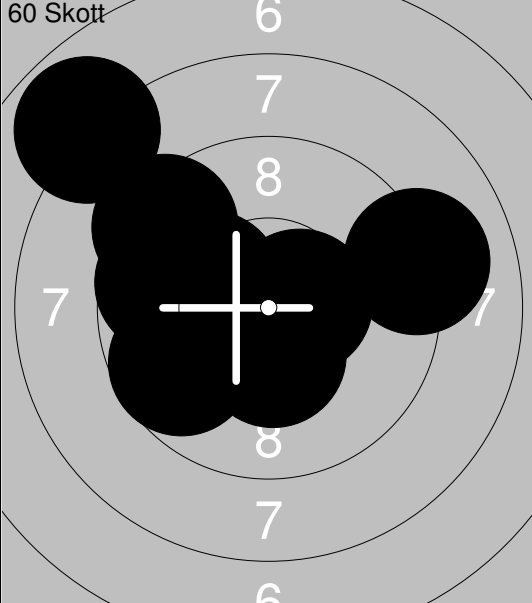
<p>60 Skott</p> 	<p>21: 9.9 ↓ 22: 9.7 ← 23: 10.0 ↓ 24: 9.2 ↓ 25: *10.4 ↘ 26: 7.2 ← 27: 9.9 → 28: *10.4 → 29: *10.3 ↘ 30: 9.7 ↓</p> <p>Serie 96.7 Total 291.9</p>	<p>60 Skott</p> 	<p>31: 9.7 ← 32: 9.8 ← 33: 7.8 ↗ 34: 9.7 ↙ 35: *10.4 ↘ 36: 9.3 ↙ 37: *10.7 ↘ 38: *10.6 → 39: 9.1 → 40: *10.2 ↘</p> <p>Serie 97.3 Total 389.2</p>
---	--	---	---

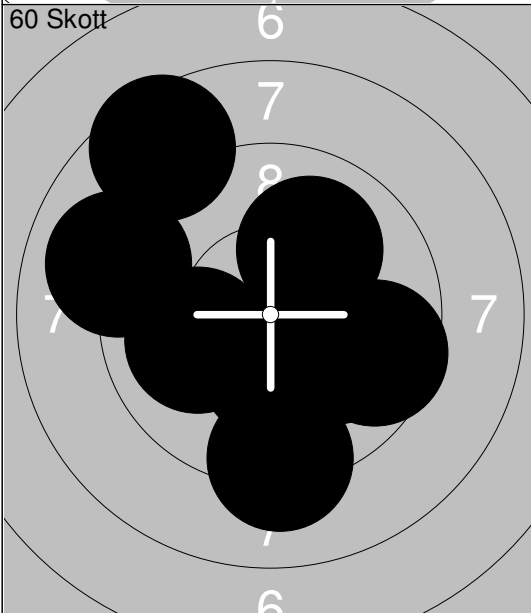
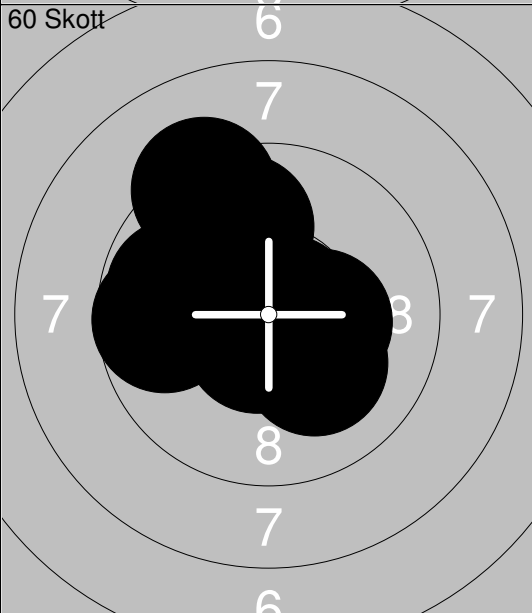
<p>60 Skott</p> 	<p>41: 10.1 ↘ 42: 9.6 → 43: 10.0 ← 44: 9.2 ↓ 45: *10.5 ↘ 46: 8.5 ↗ 47: 10.0 ↗ 48: *10.3 ↘ 49: 9.0 ← 50: *10.3 ↘</p> <p>Serie 97.5 Total 486.7</p>	<p>60 Skott</p> 	<p>51: *10.3 ↗ 52: 9.8 ↑ 53: 9.7 ← 54: 9.8 ← 55: *10.7 → 56: 9.2 ↗ 57: *10.6 ↘ 58: *10.4 ↘ 59: 10.1 ↓ 60: *10.3 →</p> <p>Serie 100.9 Total 587.6</p>
--	--	--	---

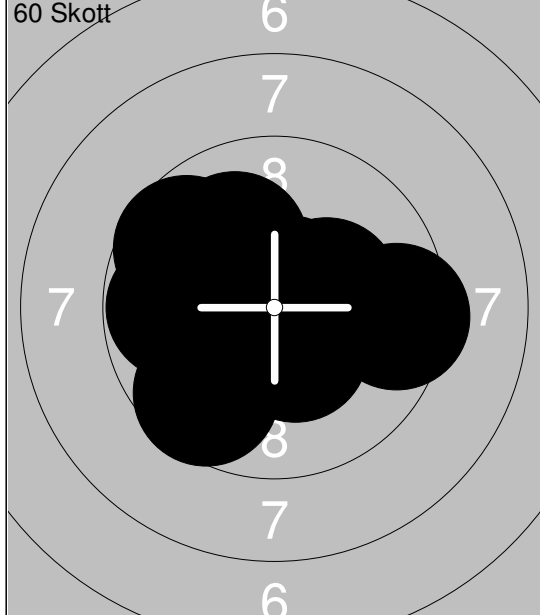

1:	9.5	→
2:	9.6	↙
3:	*10.7	↗
4:	10.0	←
5:	*10.4	↘
6:	9.7	↖
7:	10.0	↗
8:	*10.3	→
9:	9.8	←
10:	10.0	↖
Serie	100.0	
Total	100.0	

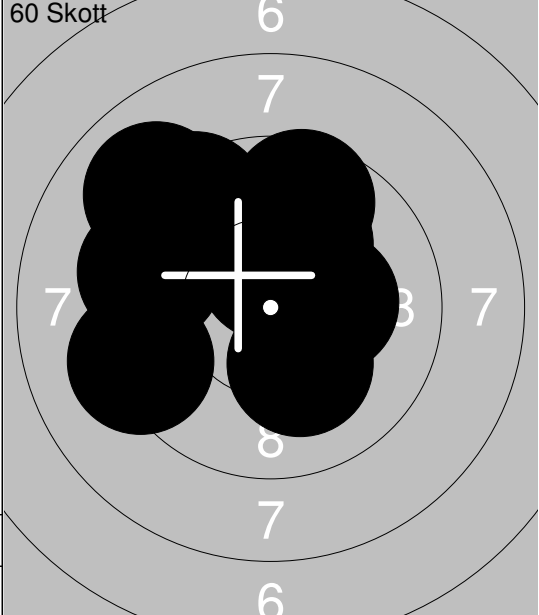

11:	9.4	↖
12:	*10.3	→
13:	*10.5	↑
14:	*10.2	↘
15:	9.0	↖
16:	10.1	↗
17:	9.4	↖
18:	9.2	↖
19:	9.7	↖
20:	9.6	↑
Serie	97.4	
Total	197.4	

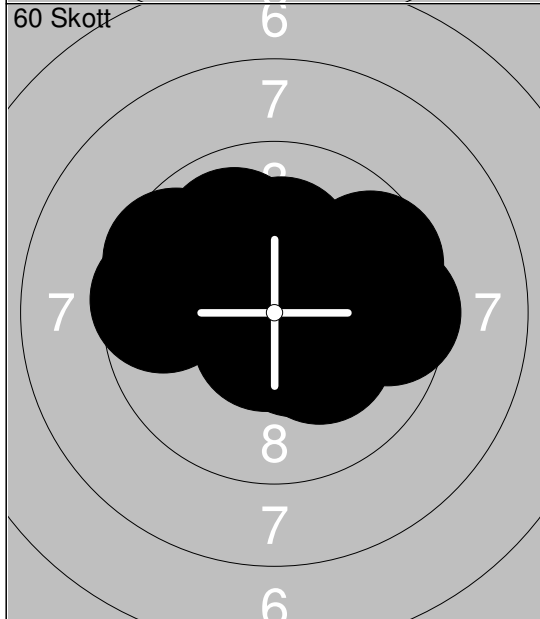

21:	9.6	←
22:	*10.3	↗
23:	9.6	→
24:	*10.2	↘
25:	*10.5	↘
26:	*10.6	↘
27:	*10.2	↑
28:	9.6	↗
29:	9.6	↖
30:	9.9	↗
Serie	100.1	
Total	297.5	

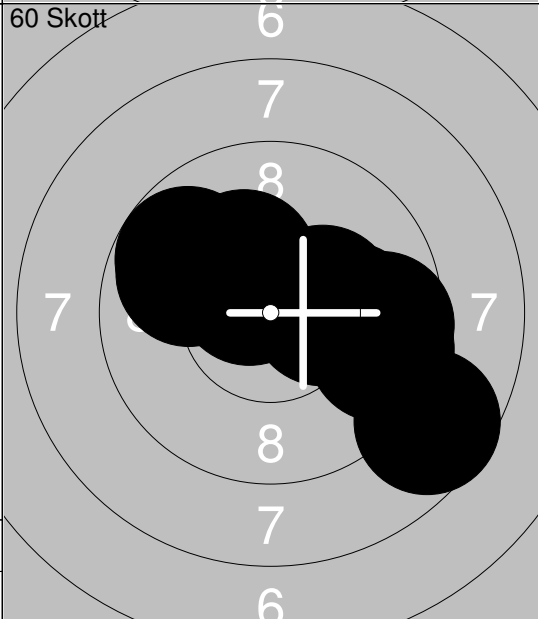

31:	8.6	↘
32:	*10.3	↖
33:	9.6	→
34:	9.8	↖
35:	10.0	→
36:	*10.3	→
37:	9.5	↗
38:	*10.6	↖
39:	*10.3	→
40:	9.8	↖
Serie	98.8	
Total	396.3	

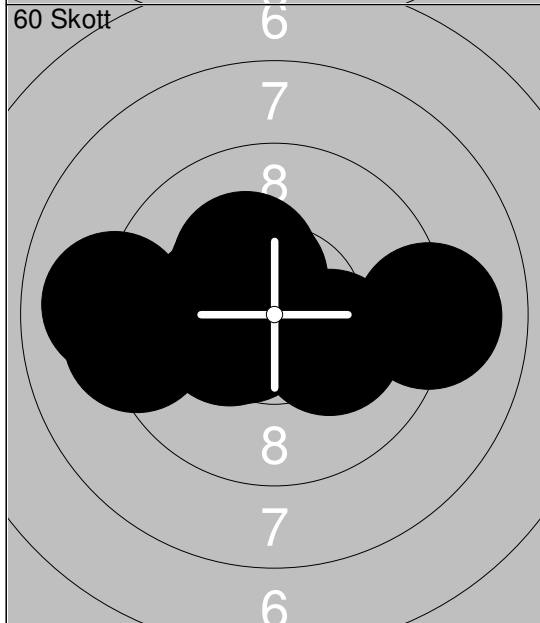

41:	*10.3	↖
42:	*10.2	↖
43:	9.2	←
44:	9.1	→
45:	*10.2	→
46:	*10.5	↖
47:	*10.2	↖
48:	9.0	←
49:	*10.4	↖
50:	*10.5	↖
Serie	99.6	
Total	495.9	

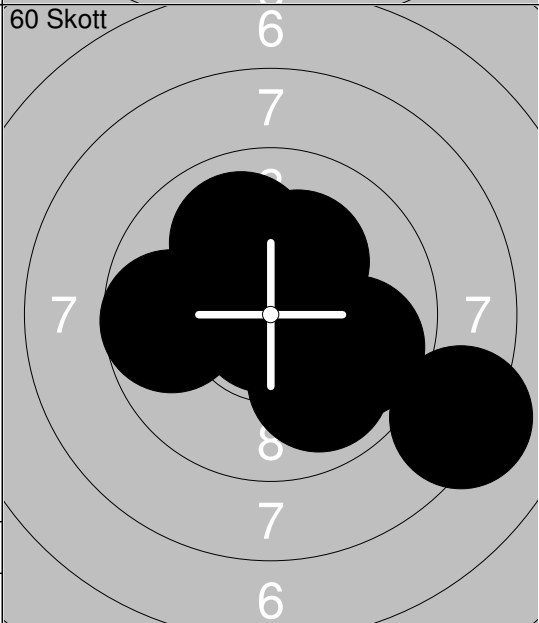

51:	9.7	←
52:	*10.7	↖
53:	9.9	↘
54:	9.8	→
55:	*10.8	↑
56:	*10.2	↗
57:	*10.5	↖
58:	10.0	↗
59:	8.2	↘
60:	*10.8	↘
Serie	100.6	
Total	596.5	

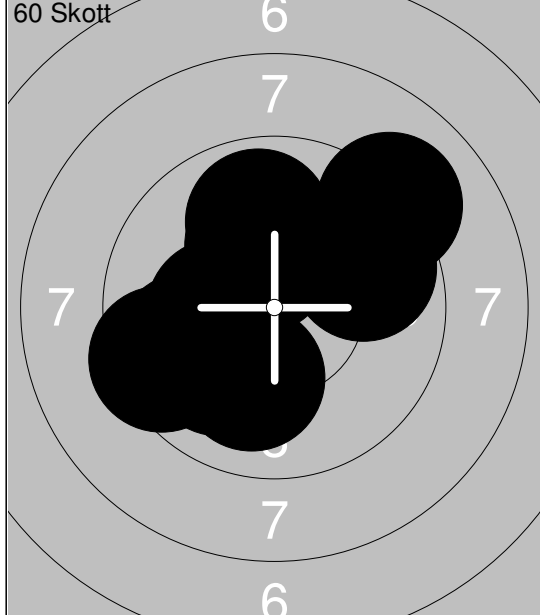

1:	9.8	→
2:	9.8	←
3:	9.9	↑
4:	10.0	↓
5:	*10.3	←
6:	10.0	↓
7:	9.1	↗
8:	*10.2	↖
9:	9.4	←
10:	*10.3	↖
Serie		98.8
Total		98.8

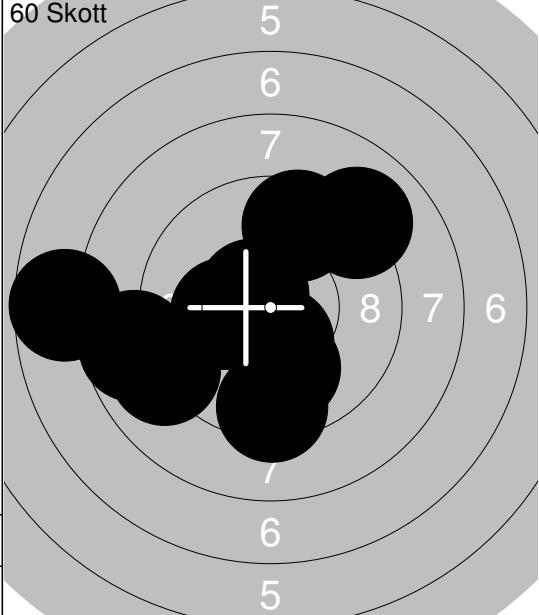

11:	9.0	↖
12:	*10.6	↖
13:	10.0	↓
14:	*10.4	↓
15:	*10.2	←
16:	9.0	↗
17:	8.7	←
18:	9.6	↑
19:	9.4	↓
20:	7.7	←
Serie		94.6
Total		193.4

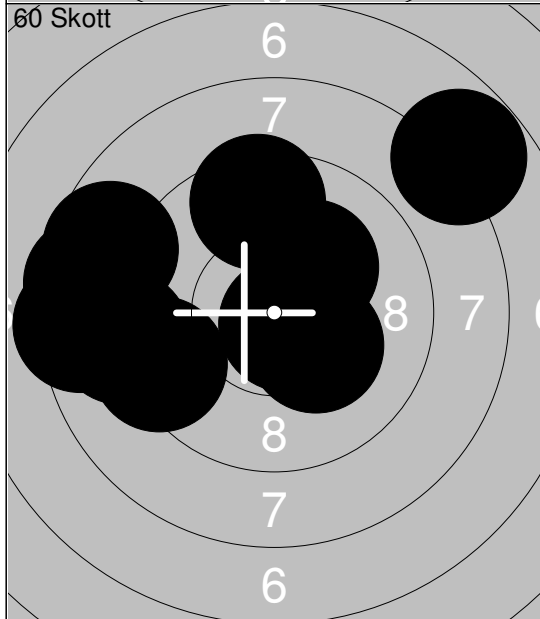

21:	*10.2	↘
22:	*10.2	↗
23:	9.5	↑
24:	8.9	←
25:	8.6	←
26:	9.3	←
27:	7.8	↗
28:	8.4	←
29:	*10.7	↘
30:	8.5	←
Serie		92.1
Total		285.5

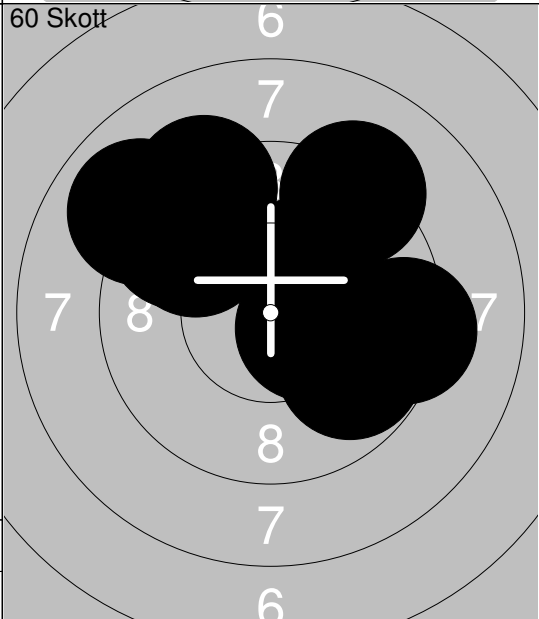

31:	9.2	↗
32:	*10.2	↗
33:	9.5	↖
34:	*10.5	→
35:	9.2	↗
36:	8.9	↖
37:	9.7	↗
38:	*10.3	→
39:	9.8	↘
40:	9.3	→
Serie		96.6
Total		382.1

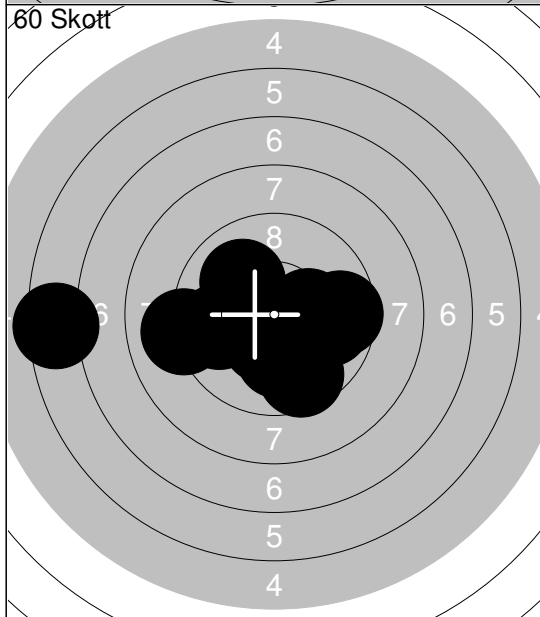

41:	10.1	↓
42:	6.4	←
43:	9.8	←
44:	10.0	↖
45:	*10.4	↓
46:	9.0	←
47:	9.6	↓
48:	9.8	→
49:	*10.2	→
50:	9.6	→
Serie		94.9
Total		477.0

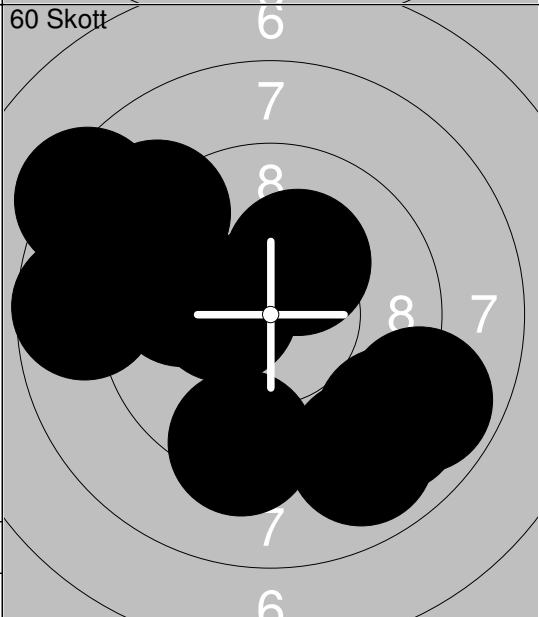

51:	9.1	↖
52:	8.9	→
53:	8.3	↖
54:	9.0	↓
55:	9.3	↓
56:	*10.4	←
57:	8.7	←
58:	8.9	↓
59:	*10.2	↗
60:	9.8	←
Serie		92.6
Total		569.6

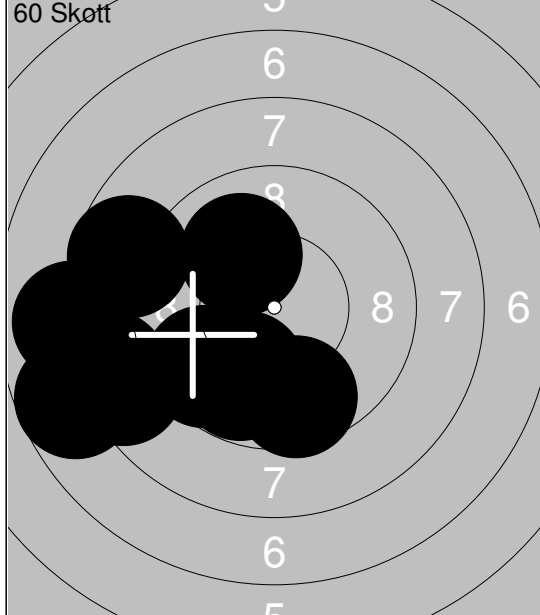

1:	8.3	↙
2:	8.4	↙
3:	8.0	↙
4:	7.7	↙
5:	9.6	↙
6:	8.7	↙
7:	9.9	↘
8:	9.6	↘
9:	9.8	↘
10:	10.0	↗
Serie		90.0
Total		90.0

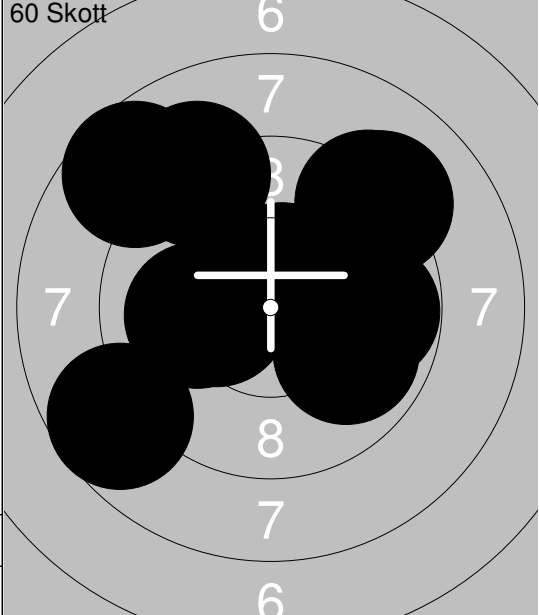

11:	9.2	↗
12:	9.9	↘
13:	9.8	→
14:	9.1	↗
15:	*10.5	↗
16:	*10.3	↙
17:	9.1	↖
18:	10.0	↙
19:	8.7	↙
20:	8.6	↖
Serie		95.2
Total		185.2

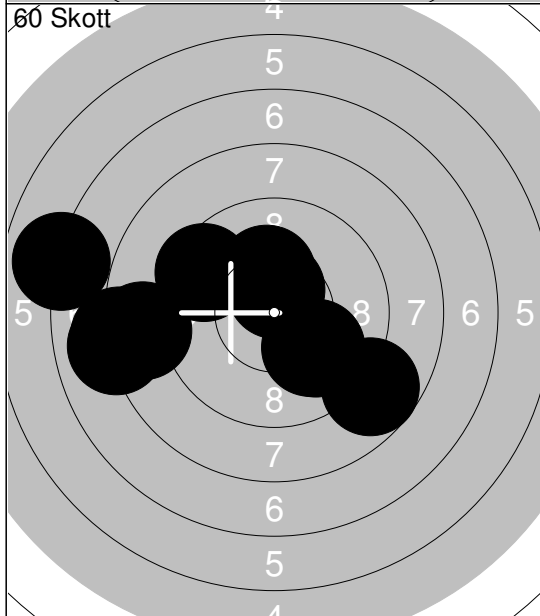

21:	*10.2	↗
22:	9.5	↙
23:	9.9	↘
24:	8.1	↙
25:	8.5	↙
26:	6.9	↙
27:	8.7	↘
28:	8.0	↙
29:	10.0	↘
30:	*10.5	↗
Serie		90.3
Total		275.5

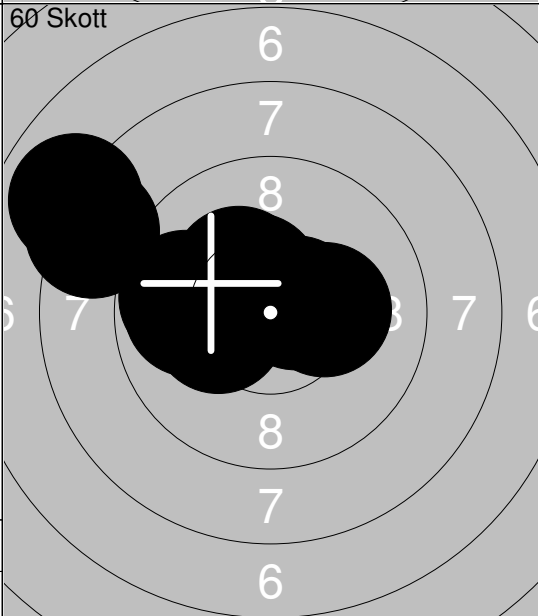

31:	*10.6	→
32:	9.8	↙
33:	9.9	↙
34:	*10.2	↙
35:	*10.3	↙
36:	8.3	↙
37:	*10.5	↗
38:	*10.3	↗
39:	*10.2	→
40:	7.9	↙
Serie		98.0
Total		373.5

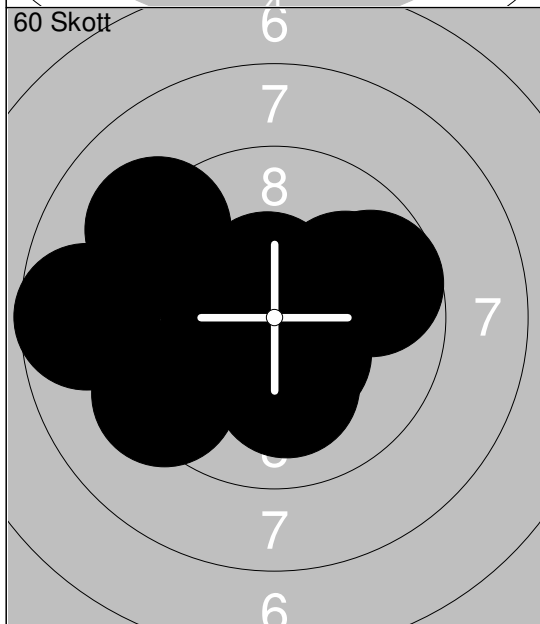

41:	9.2	↖
42:	*10.4	↘
43:	9.7	→
44:	9.3	↙
45:	*10.4	↙
46:	*10.7	↘
47:	8.7	↙
48:	10.1	↘
49:	*10.5	↗
50:	10.0	→
Serie		99.0
Total		472.5

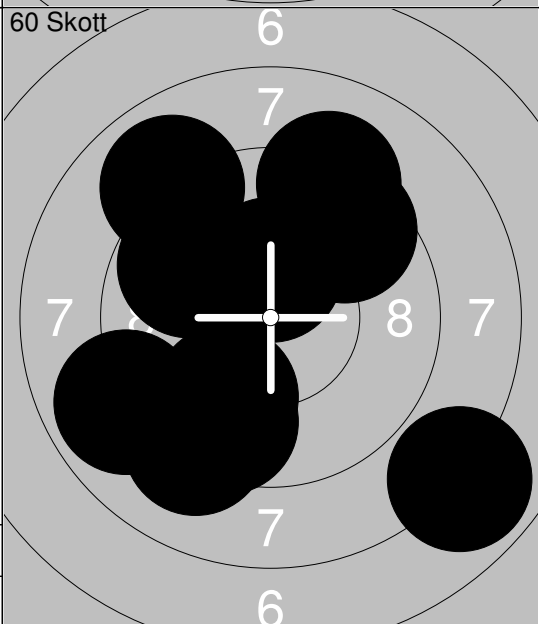

51:	9.5	↗
52:	9.8	↘
53:	8.9	↙
54:	*10.4	↗
55:	7.9	↘
56:	8.9	↖
57:	9.8	↙
58:	9.6	↘
59:	9.2	↗
60:	9.1	↘
Serie		93.1
Total		565.6

<p>60 Skott</p>	<p>60 Skott</p>
<p>60 Skott</p>	<p>60 Skott</p>
<p>60 Skott</p>	<p>60 Skott</p>