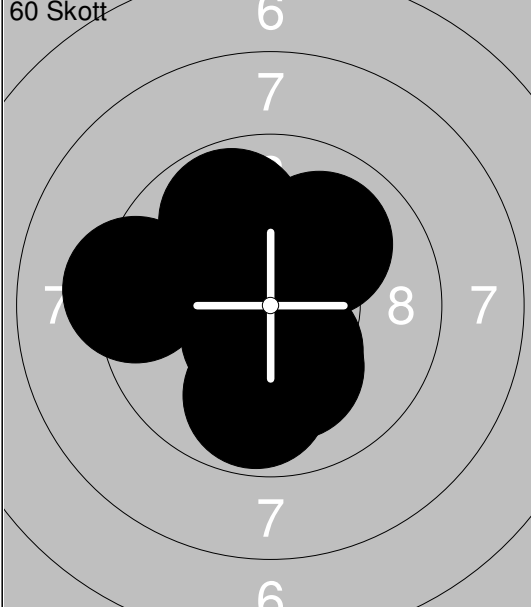
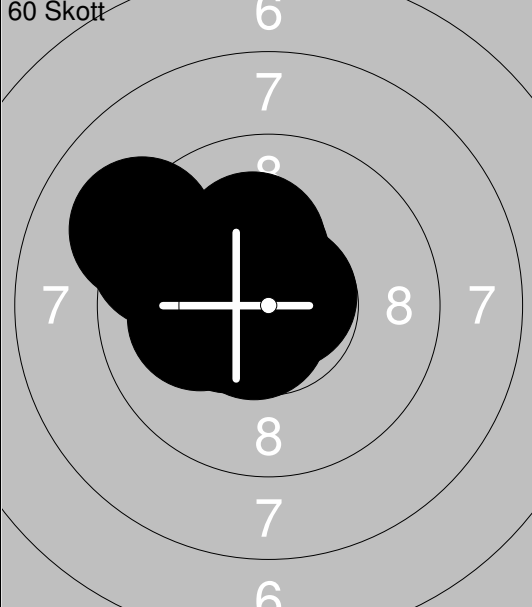
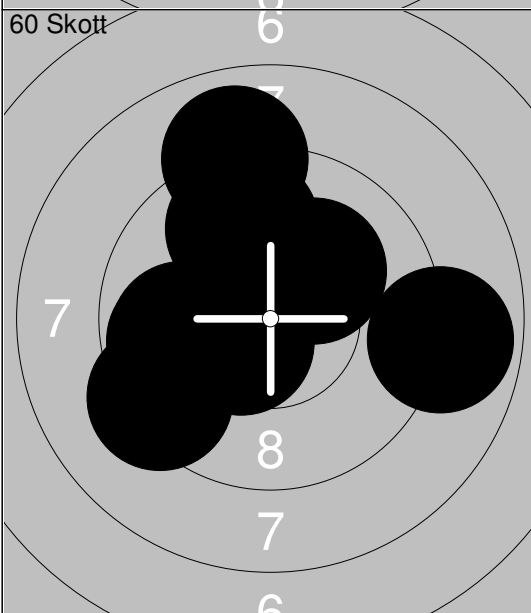
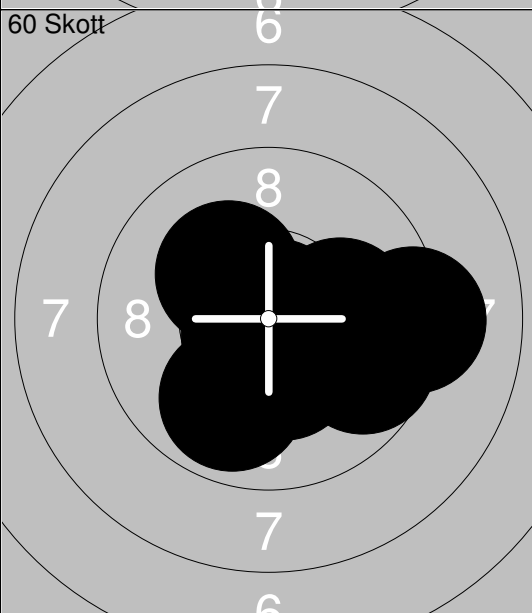
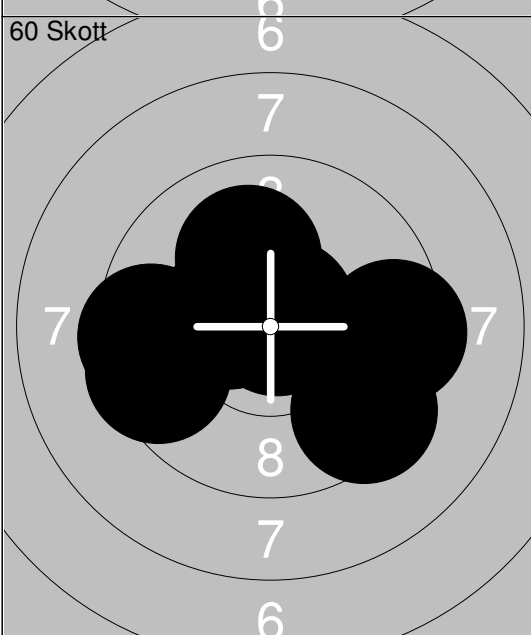
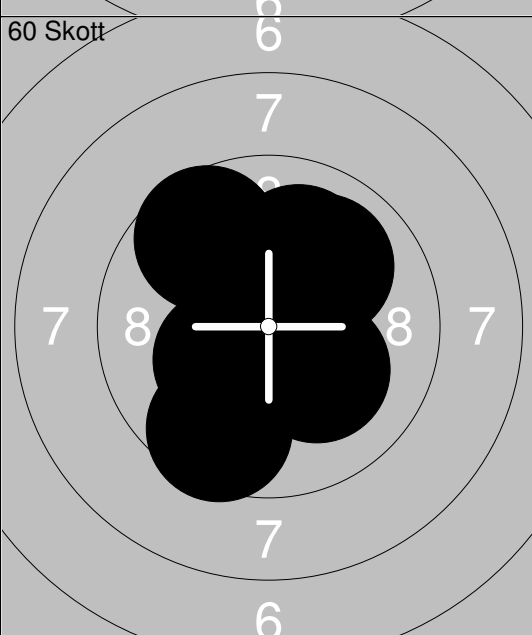
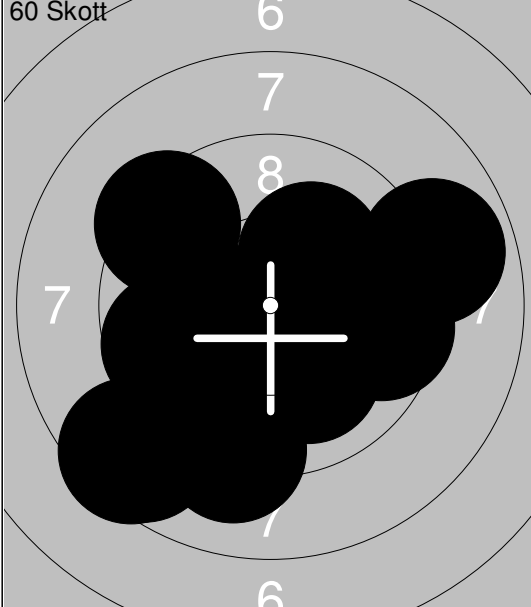
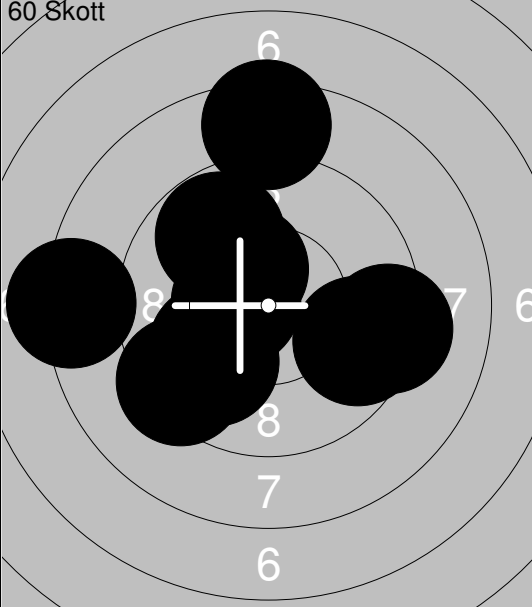
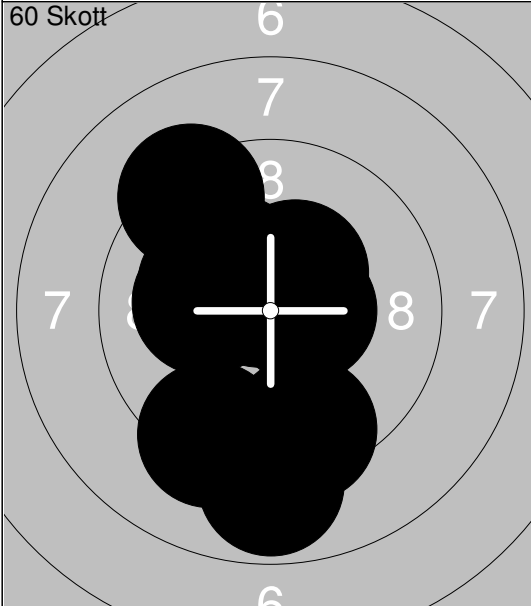
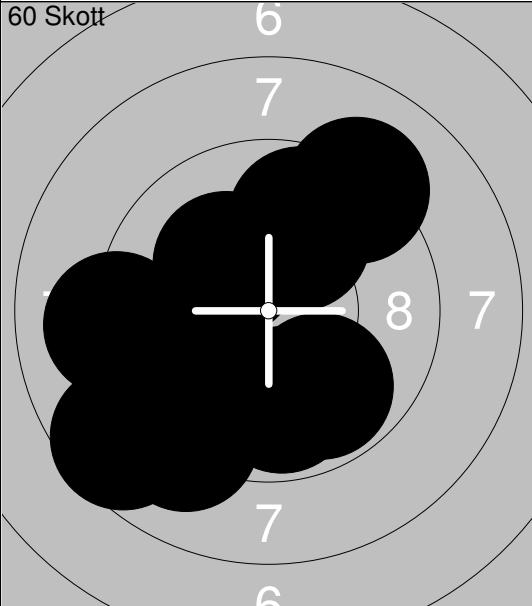
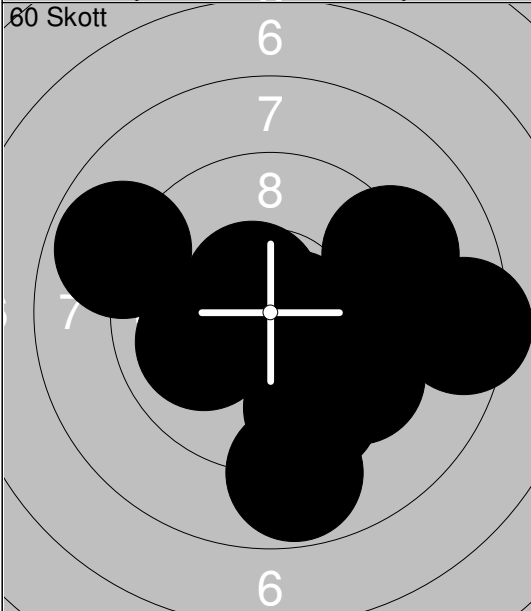
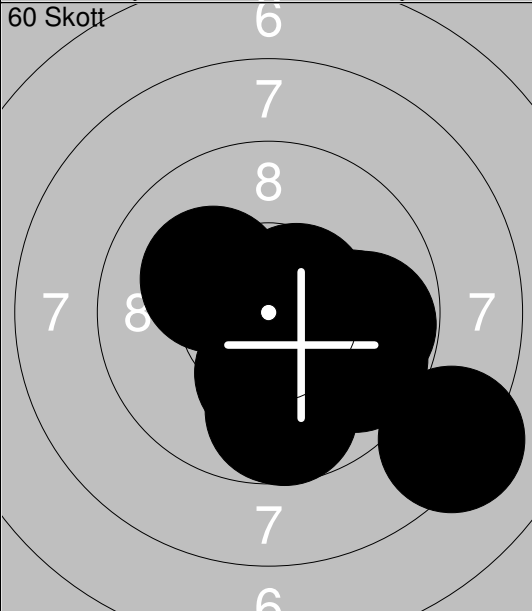

<p>60 Skott</p> 	<p>1: 9.8 ↗</p> <p>2: *10.2↓</p> <p>3: 10.0 ↗</p> <p>4: *10.5↗</p> <p>5: 9.9 ↓</p> <p>6: 9.8 ↓</p> <p>7: *10.5↓</p> <p>8: *10.6↗</p> <p>9: 9.3 ←</p> <p>10: *10.3↓</p> <hr/> <p>Serie 100.9</p> <hr/> <p>Total 100.9</p>	<p>60 Skott</p> 	<p>11: 9.2 ↖</p> <p>12: *10.4↖</p> <p>13: *10.6↖</p> <p>14: 9.5 ↖</p> <p>15: *10.3↗</p> <p>16: *10.7↗</p> <p>17: *10.2↗</p> <p>18: 10.1 ←</p> <p>19: *10.5↖</p> <p>20: *10.6↖</p> <hr/> <p>Serie 102.1</p> <hr/> <p>Total 203.0</p>
<p>60 Skott</p> 	<p>21: *10.5↖</p> <p>22: 9.3 ↖</p> <p>23: *10.2↗</p> <p>24: 8.9 →</p> <p>25: 9.9 ←</p> <p>26: 9.8 ↗</p> <p>27: 8.9 ↗</p> <p>28: 9.8 ←</p> <p>29: *10.5↖</p> <p>30: 9.8 ↗</p> <hr/> <p>Serie 97.6</p> <hr/> <p>Total 300.6</p>	<p>60 Skott</p> 	<p>31: 9.7 →</p> <p>32: *10.8↗</p> <p>33: *10.2↖</p> <p>34: 10.1 →</p> <p>35: *10.7↖</p> <p>36: *10.4↓</p> <p>37: 9.2 →</p> <p>38: *10.3→</p> <p>39: *10.3↓</p> <p>40: 9.9 ↓</p> <hr/> <p>Serie 101.6</p> <hr/> <p>Total 402.2</p>
<p>60 Skott</p> 	<p>41: 9.4 →</p> <p>42: *10.7↗</p> <p>43: *10.9↗</p> <p>44: *10.4↖</p> <p>45: 9.5 ←</p> <p>46: 9.5 ←</p> <p>47: 10.1 ↗</p> <p>48: 9.4 ↘</p> <p>49: *10.7↗</p> <p>50: *10.7↖</p> <hr/> <p>Serie 101.3</p> <hr/> <p>Total 503.5</p>	<p>60 Skott</p> 	<p>51: *10.2↘</p> <p>52: *10.6↓</p> <p>53: *10.4↓</p> <p>54: 9.6 ↓</p> <p>55: 10.0 ↗</p> <p>56: *10.6↖</p> <p>57: 10.0 ↗</p> <p>58: 9.6 ↖</p> <p>59: *10.7↗</p> <p>60: *10.3↖</p> <hr/> <p>Serie 102.0</p> <hr/> <p>Total 605.5</p>

<p>60 Skott</p>	<p>60 Skott</p>
Serie 102.2 Total 102.2	Serie 103.3 Total 205.5
<p>60 Skott</p>	<p>60 Skott</p>
Serie 100.8 Total 306.3	Serie 99.4 Total 405.7
<p>60 Skott</p>	<p>60 Skott</p>
Serie 101.2 Total 506.9	Serie 98.0 Total 604.9

<p>60 Skott</p> 	<p>1: 10.1 ← 2: 10.0 ↓ 3: 8.5 ↓ 4: *10.2 ↗ 5: 8.6 ↓ 6: 9.6 → 7: 9.7 ← 8: 9.1 ↓ 9: 9.3 ↖ 10: 8.9 →</p> <p>Serie 94.0 Total 94.0</p>	<p>60 Skott</p> 	<p>11: 9.8 ↗ 12: 8.2 ← 13: *10.3 ↖ 14: 9.6 → 15: *10.5 ↖ 16: 9.9 ↓ 17: 9.3 ↓ 18: 10.0 ↖ 19: 8.4 ↑ 20: 9.3 →</p> <p>Serie 95.3 Total 189.3</p>
--	---	--	--

<p>60 Skott</p> 	<p>21: 9.4 ↓ 22: *10.4 ↗ 23: *10.3 ↖ 24: *10.7 ↖ 25: 9.3 ↓ 26: 8.8 ↓ 27: *10.5 → 28: 9.3 ↗ 29: *10.2 ↖ 30: 10.1 ←</p> <p>Serie 99.0 Total 288.3</p>	<p>60 Skott</p> 	<p>31: *10.2 ↖ 32: 9.8 ↑ 33: 10.0 ↑ 34: 9.1 ↗ 35: 8.6 ↓ 36: 9.1 ↓ 37: 9.8 ↓ 38: 10.0 ← 39: 9.1 ← 40: 9.8 ↓</p> <p>Serie 95.5 Total 383.8</p>
---	--	---	---

<p>60 Skott</p> 	<p>41: 8.8 ↓ 42: 9.2 → 43: 8.4 → 44: 8.9 ← 45: *10.7 → 46: *10.6 ↖ 47: 9.6 ↓ 48: 10.0 ← 49: 9.6 ↓ 50: *10.4 ↓</p> <p>Serie 96.2 Total 480.0</p>	<p>60 Skott</p> 	<p>51: 9.7 → 52: *10.6 ↗ 53: 9.9 → 54: *10.2 ↓ 55: 9.7 ↓ 56: 9.8 → 57: *10.2 ↖ 58: 9.7 ↓ 59: 8.2 → 60: *10.2 ↓</p> <p>Serie 98.2 Total 578.2</p>
--	--	--	---

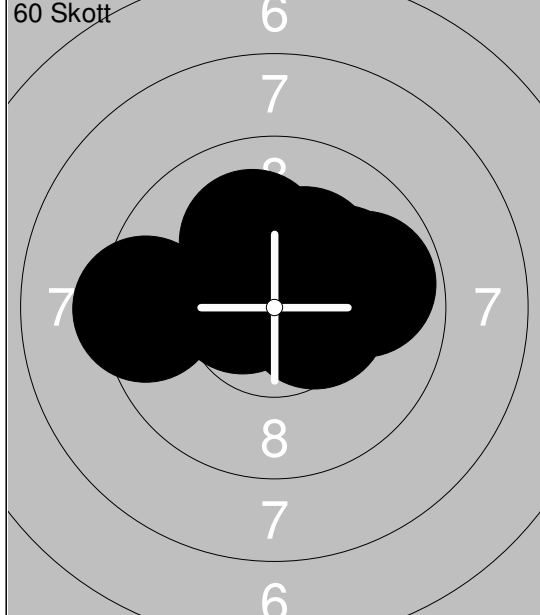

1:	9.8	→
2:	*10.6	↑
3:	*10.5	→
4:	*10.3	↗
5:	*10.7	↗
6:	*10.6	↖
7:	9.4	←
8:	10.1	↑
9:	10.1	→
10:	*10.6	↑
Serie		102.7
Total		102.7

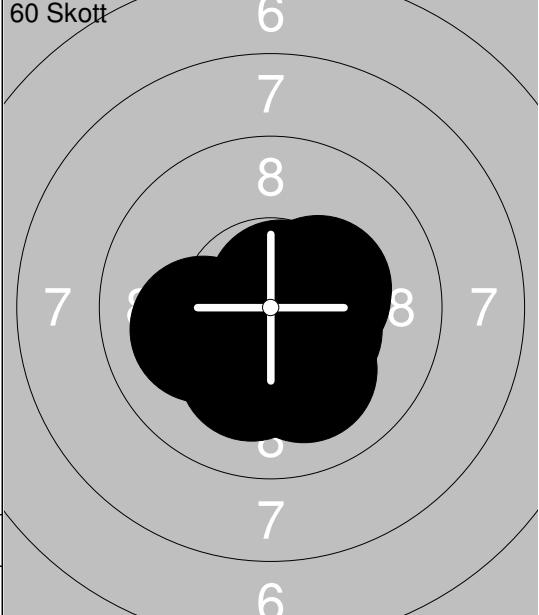

11:	*10.4	→
12:	*10.4	↘
13:	*10.6	→
14:	10.1	↘
15:	10.1	←
16:	*10.5	↘
17:	*10.4	↘
18:	*10.3	→
19:	*10.7	↗
20:	*10.2	↘
Serie		103.7
Total		206.4

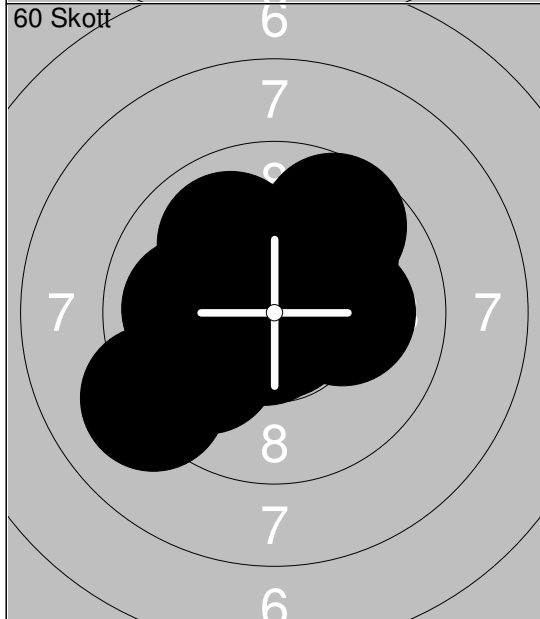

21:	9.1	←
22:	10.0	↗
23:	*10.7	↘
24:	9.7	↗
25:	10.0	↖
26:	*10.8	↘
27:	10.1	→
28:	10.0	←
29:	10.1	←
30:	9.9	←
Serie		100.4
Total		306.8

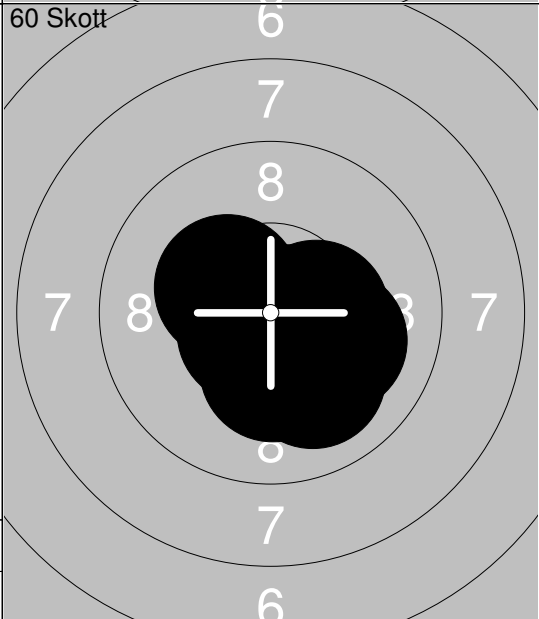

31:	10.1	→
32:	*10.5	↘
33:	*10.4	→
34:	*10.8	→
35:	*10.6	↘
36:	*10.9	↘
37:	*10.8	→
38:	10.0	↘
39:	*10.3	↖
40:	*10.3	↘
Serie		104.7
Total		411.5

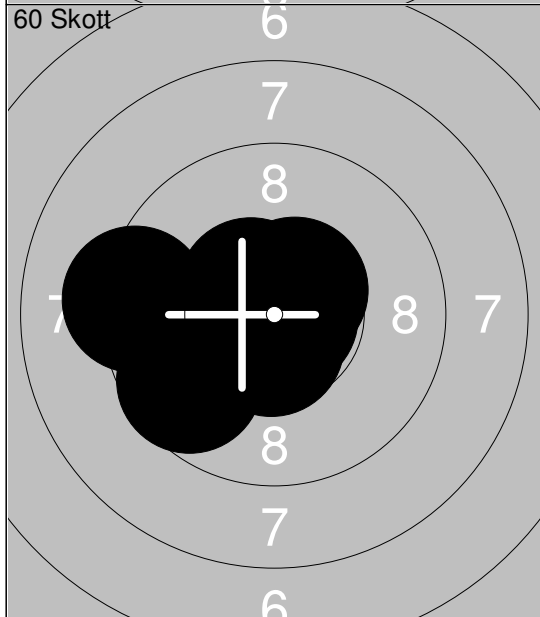

41:	*10.6	↘
42:	*10.6	↗
43:	9.2	←
44:	*10.5	↖
45:	*10.8	→
46:	9.6	←
47:	9.9	←
48:	*10.4	↖
49:	*10.8	↗
50:	*10.4	↖
Serie		102.8
Total		514.3

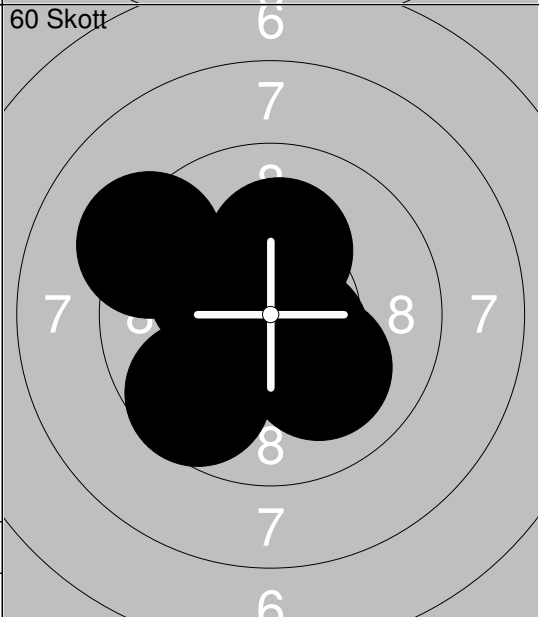

51:	*10.5	↘
52:	9.2	↖
53:	10.1	↘
54:	*10.8	↘
55:	*10.3	↖
56:	9.6	↖
57:	*10.8	↖
58:	*10.4	↑
59:	*10.5	↑
60:	*10.2	↑
Serie		102.4
Total		616.7

<p>60 Skott</p>	<p>1: 9.7 ↗ 2: 9.7 → 3: 9.9 ↓ 4: 10.0 → 5: 9.7 ↖ 6: *10.6 → 7: *10.5 ↖ 8: 10.1 ↘ 9: 9.9 ↑ 10: *10.6 ↖</p> <p>Serie 100.7 Total 100.7</p>	<p>60 Skott</p>	<p>11: *10.2 ↑ 12: 10.1 → 13: *10.4 ↖ 14: *10.4 ↗ 15: *10.6 ↖ 16: 10.0 ↑ 17: 10.0 ↖ 18: *10.3 ↖ 19: 9.8 ↘ 20: 9.6 ↑</p> <p>Serie 101.4 Total 202.1</p>
<p>60 Skott</p>	<p>21: *10.6 ↗ 22: 9.4 → 23: 10.0 ↖ 24: 9.4 ← 25: 10.1 ↖ 26: *10.4 → 27: *10.6 ↘ 28: 9.8 ← 29: *10.4 ↘ 30: 9.7 ↖</p> <p>Serie 100.4 Total 302.5</p>	<p>60 Skott</p>	<p>31: *10.8 ↘ 32: *10.4 ↘ 33: 10.0 → 34: *10.8 ↖ 35: 9.6 ← 36: 9.8 → 37: 9.8 → 38: *10.5 ↖ 39: 9.5 ← 40: 9.7 →</p> <p>Serie 100.9 Total 403.4</p>
<p>60 Skott</p>	<p>41: *10.2 ↘ 42: *10.4 ↖ 43: 10.1 ↗ 44: *10.3 ↘ 45: *10.2 ↘ 46: *10.7 → 47: 10.0 ↖ 48: 9.9 → 49: 10.1 → 50: *10.4 ↖</p> <p>Serie 102.3 Total 505.7</p>	<p>60 Skott</p>	<p>51: 10.0 → 52: *10.2 ↖ 53: *10.5 ↘ 54: *10.3 ↘ 55: 9.4 ↓ 56: *10.7 ↘ 57: 9.6 ↖ 58: 10.1 ↘ 59: 9.7 ↘ 60: *10.2 ↖</p> <p>Serie 100.7 Total 606.4</p>

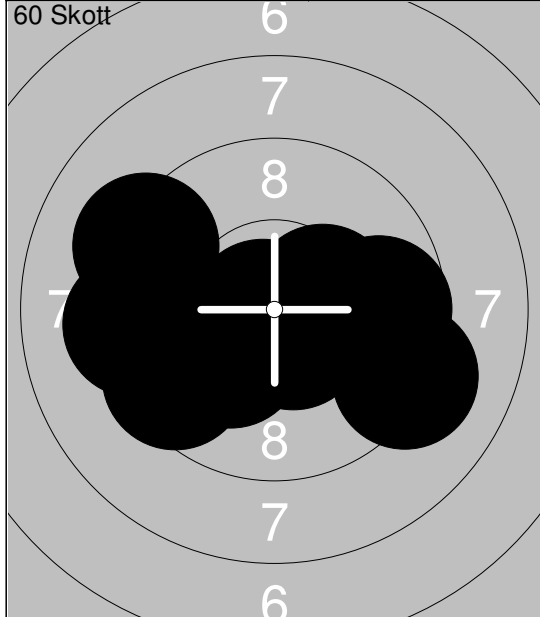

1:	*10.4 ↙
2:	9.2 ←
3:	*10.2 ↙
4:	9.5 ←
5:	*10.8 ↙
6:	9.7 →
7:	9.2 ←
8:	*10.5 ↘
9:	*10.3 →
10:	9.2 ↘
Serie 99.0	
Total 99.0	

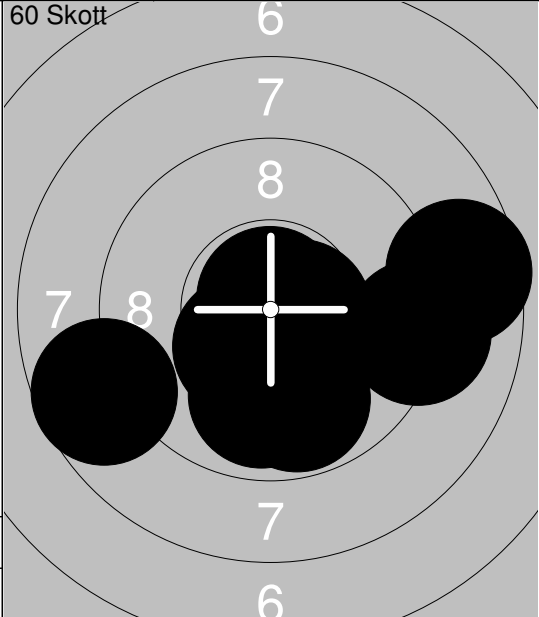

11:	8.6 →
12:	9.1 →
13:	*10.4 ↙
14:	9.9 ↓
15:	9.8 ↓
16:	*10.6 →
17:	*10.6 →
18:	*10.8 ↑
19:	8.7 ←
20:	*10.8 ↙
Serie 99.3	
Total 198.3	

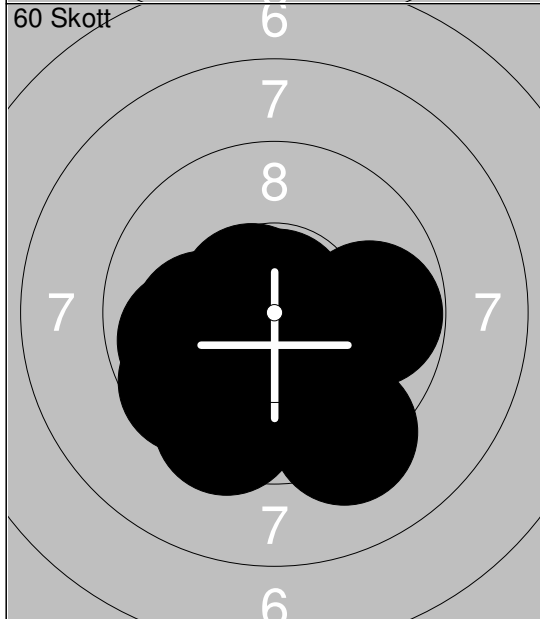

21:	9.8 →
22:	*10.8 ↑
23:	10.1 ←
24:	9.6 ←
25:	*10.3 ↘
26:	9.9 ←
27:	9.5 ↓
28:	9.3 ↓
29:	*10.5 ↙
30:	*10.6 ↙
Serie 100.4	
Total 298.7	

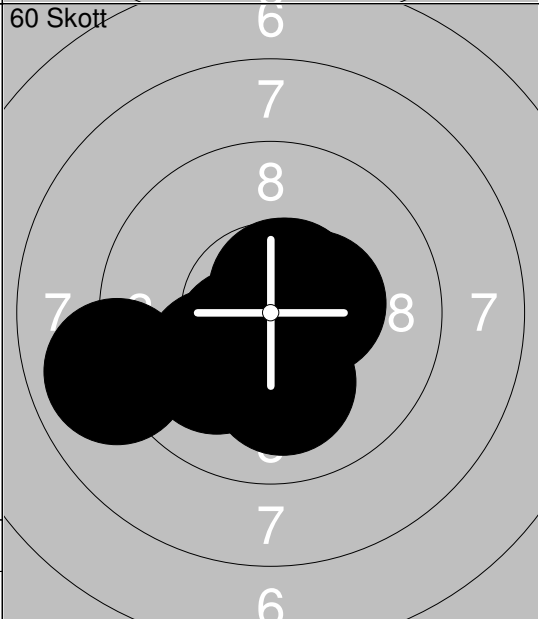

31:	8.9 ←
32:	*10.6 ↗
33:	*10.4 →
34:	*10.5 ↙
35:	*10.8 →
36:	10.1 ↓
37:	*10.7 ↗
38:	*10.6 ↗
39:	*10.5 ↘
40:	10.1 ←
Serie 103.2	
Total 401.9	

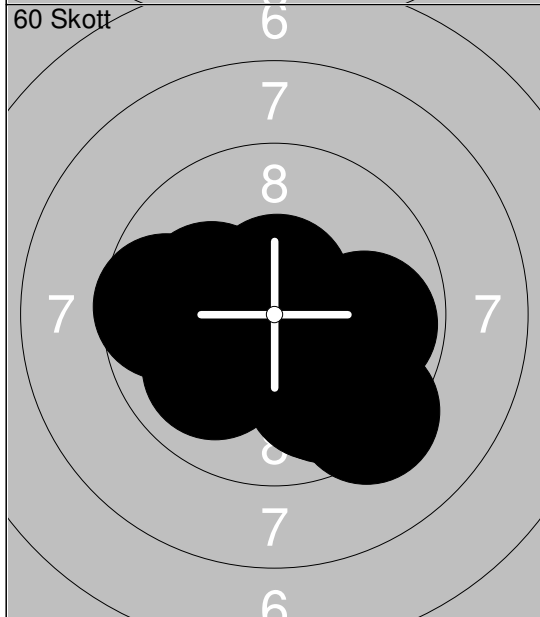

41:	9.8 →
42:	10.1 ↙
43:	9.6 ←
44:	9.8 ↓
45:	10.0 ↙
46:	10.1 ←
47:	*10.8 ↘
48:	*10.6 ↑
49:	9.3 ↓
50:	9.9 ↓
Serie 100.0	
Total 501.9	

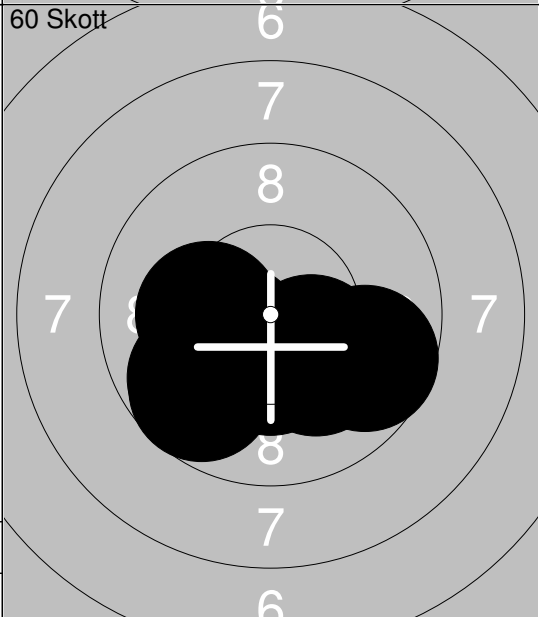

51:	9.7 ↙
52:	*10.4 ↘
53:	*10.3 ↘
54:	9.7 →
55:	*10.4 ↙
56:	*10.3 ↙
57:	9.8 ←
58:	10.1 ↓
59:	*10.2 ↙
60:	*10.4 ↘
Serie 101.3	
Total 603.2	

<p>60 Skott</p> <p style="text-align: right;">Serie 100.9 Total 100.9</p>	<p>60 Skott</p> <p style="text-align: right;">Serie 103.0 Total 203.9</p>
<p>60 Skott</p> <p style="text-align: right;">Serie 102.5 Total 306.4</p>	<p>60 Skott</p> <p style="text-align: right;">Serie 102.1 Total 408.5</p>
<p>60 Skott</p> <p style="text-align: right;">Serie 98.5 Total 507.0</p>	<p>60 Skott</p> <p style="text-align: right;">Serie 104.1 Total 611.1</p>

<p>60 Skott</p>	<p>60 Skott</p>
<p>60 Skott</p>	<p>60 Skott</p>
<p>60 Skott</p>	<p>60 Skott</p>

<p>60 Skott</p>	<p>60 Skott</p>
<p>60 Skott</p>	<p>60 Skott</p>
<p>60 Skott</p>	<p>60 Skott</p>

<p>60 Skott</p>	<p>1: 9.7 ↓</p> <p>2: 9.6 ↗</p> <p>3: 8.2 →</p> <p>4: 10.1 →</p> <p>5: 10.1 ↑</p> <p>6: 10.0 →</p> <p>7: *10.5 ↘</p> <p>8: 8.8 ←</p> <p>9: *10.5 →</p> <p>10: *10.4 ↖</p> <hr/> <p>Serie 97.9</p> <hr/> <p>Total 97.9</p>	<p>60 Skott</p>	<p>11: 9.4 ↘</p> <p>12: *10.3 ↓</p> <p>13: 9.0 ↓</p> <p>14: 10.1 ←</p> <p>15: 9.5 ↘</p> <p>16: 9.8 ↖</p> <p>17: 8.6 ↘</p> <p>18: 9.5 ←</p> <p>19: 9.6 ↑</p> <p>20: *10.6 ↘</p> <hr/> <p>Serie 96.4</p> <hr/> <p>Total 194.3</p>
<p>60 Skott</p>	<p>21: 9.7 →</p> <p>22: *10.3 ↘</p> <p>23: 10.1 →</p> <p>24: *10.6 ↘</p> <p>25: 9.5 ↑</p> <p>26: 10.1 ↖</p> <p>27: *10.6 →</p> <p>28: 9.9 ↓</p> <p>29: 9.6 →</p> <p>30: 8.6 ←</p> <hr/> <p>Serie 99.0</p> <hr/> <p>Total 293.3</p>	<p>60 Skott</p>	<p>31: *10.3 ↘</p> <p>32: 9.2 ↖</p> <p>33: *10.6 ↖</p> <p>34: 9.9 →</p> <p>35: 10.1 ↑</p> <p>36: *10.5 ↗</p> <p>37: 9.6 ←</p> <p>38: 9.4 →</p> <p>39: *10.4 ↑</p> <p>40: 10.1 ↘</p> <hr/> <p>Serie 100.1</p> <hr/> <p>Total 393.4</p>
<p>60 Skott</p>	<p>41: 9.9 ↘</p> <p>42: *10.5 ↗</p> <p>43: 9.7 ↖</p> <p>44: *10.4 →</p> <p>45: 9.6 →</p> <p>46: *10.7 ↑</p> <p>47: *10.6 ↘</p> <p>48: 9.8 →</p> <p>49: *10.6 ↘</p> <p>50: 9.9 ↘</p> <hr/> <p>Serie 101.7</p> <hr/> <p>Total 495.1</p>	<p>60 Skott</p>	<p>51: 9.1 →</p> <p>52: *10.2 ↘</p> <p>53: *10.4 →</p> <p>54: 8.7 ↖</p> <p>55: 9.5 ↓</p> <p>56: 8.0 →</p> <p>57: *10.5 ↘</p> <p>58: *10.6 ↑</p> <p>59: *10.4 ↖</p> <p>60: 7.8 ↖</p> <hr/> <p>Serie 95.2</p> <hr/> <p>Total 590.3</p>